

ADDENDUM 1

DATE: February 10, 2022
PROJECT: PHB 2100 – Public Health Education and Research Building (A/E)
RFQ NO: 744-Q2202
OWNER: The University of Texas Health Science Center at Houston
TO: Prospective Proposers

This Addendum forms part of and modifies Proposal Documents dated, January 28, 2022, with amendments and additions noted below.

1. Clarifications, Questions and Answers:

1. Question: Will the Vivarium be distributed throughout the building or centrally located?
Answer: The vivarium will be centrally located within the building.
2. Question: No conference room/collaboration spaces are listed. Do you anticipate interdisciplinary collaboration and video conferencing across multiple campuses/locations? International video collaboration?
Answer: Yes. There will be collaboration and heavy AV capabilities that allow teaching between the School of Public Health's many schools across Texas. International video collaboration will also be a need.
3. Question: The RFQ indicates the following: The Preliminary Project Cost (PPC) for this project is \$210,000,000.00. The PPC includes a Construction Cost Limitation (CCL) for the Architect/Engineer of \$12,600,00.00. Fees, furnishings, equipment, other work, miscellaneous expenses, and contingencies make up the balance of the PPC. Please confirm whether this is the anticipated A/E fee limit, and not the CCL. What is the anticipated CCL.
Answer: The PPC will not exceed \$300M. The CCL is approximately \$280M. The A/E fee is 6% of the CCL (\$16,800,000)
4. Question: Can you please confirm that there are no projections to include simulated patient spaces within the facility?
Answer: The School of Public Health will have a simulated patient space.
5. Question: Regarding *Item 3.7.1: State your compliance with the Campus Master Plan and explain how you anticipate incorporating the requirements of the Campus Master Plan into the design of the project* - Could you please provide a link or a copy of the Campus Master Plan that we may review?
Answer: See Appendix H – South Campus Master Plan
6. Question: Also on the purchasing web site, when I click the link to attachment 5.6 Standard Specifications, it opens 5.7 – which is a duplicate of the link to 5.7. Can you please provide a new link to 5.6?
Answer: Link has been corrected

7. Question: When looking at the schedule, I noticed the Notice To Proceed on page 10 states February 2022. I wanted to double check that this is an error and assume it should read February 2023?
Answer: That is correct. NTP would be February 2023.
8. Question: A quick question as I was not able to join the call-in yesterday. What is the anticipated Construction Cost Limitation (CCL) for this project? I see in the RFQ, it states it as \$12,000,00.00. While this is missing a zero to be \$12M, I would normally expect that cost to be about 70% to 75% of the PPC.
Answer: The PPC will not exceed \$300M. The CCL is approximately \$280M. The A/E fee is 6% of the CCL (\$16,800,000)
9. Question: Is the full HSP required, or just a HUB Commitment letter, for the submittal due 2/25/22?
Answer: The HSP is required per 1.13.1 of the RFQ.
10. The RFQ does not appear to list the engineers/consultants you would like to see included in the Statement of Qualifications and HUB plan. Is it the intention of UTHealth to select only the Architect at this point? If yes, is there a different HUB goal for Architecture services only? If not, which engineers/consultants would you like to be included?
Answer: The A/E firms are responsible for determining the engineers/consultants they will carry under them. The A/E portion HUB goal is 23.70% for professional services and the CMAR HUB goal is 21.10% for building construction. I guess we should have listed on the services ie. Structural, Civil, Landscape, MEP, Environment consultants etc.
11. Question: For section 3.4 Criteria Four: Respondent's Performance on Past Projects - is it acceptable to include projects that have completed permitting but are still in the construction phase?
Answer: It is acceptable to provide projects that are currently in construction phase. We prefer to see projects at minimum 75% complete on construction.
12. Question: In terms of project relevance - is UTHealth more interested in program similarity (BSL-2, vivarium etc..)? project size? Construction cost/duration? other key features such as campus creation? Sustainability? Or something else?
Answer: All of the above. We prefer to see similar projects that align with the size, type, & cost of this new building.
13. Question: For section 3.4.2 - Are there certain design awards UTHealth is more or less interested in?
Answer: No.
14. Question: For section 3.2.2 - May the three requested audited financial statements be submitted under separate cover and not counted toward the 50-page count?
Answer: Acceptable.
15. Question: For section 4.1.2 - Can you clarify what is meant by "[STEP ONE OF THREE STEP PROCESS TYPICALLY REQUIRES 8-10 PAGES EXCLUDING THE FORM 254]" We do not see the referenced Form 254 provided.
Answer: Form 254 is to be provided by the A/E firm. UTH does not provide a template.

16. Question: What are the sustainability goals for the project?

Answer: Not yet determined.

17. Question: Can you share the current Master Plan?

Answer: See Appendix H – South Campus Master Plan.

18. Question: Can you please share the type of animals in the vivarium and if there will be large animals?

Answer: Only small animals are planned at this time.

19. Question: 2.3 states that the PPC is \$210,000,000.00 and the CCL is \$12,600,00.00 (which would really be \$1,260,000.00 with comas adjusted) ; 14.4 states the CCL is eighty four million dollars (\$210,000,000.00).; Basic Services Fee \$210,000,000 CCL X 6% fee = \$12,600,000.00 Basic Services Fee – Please clarify the PPC and CCL

Answer: The PPC will not exceed \$300M. The CCL is approximately \$280M. The A/E fee is 6% of the CCL (\$16,800,000).

END OF ADDENDUM 1

Appendix H

South Campus Master Framework



Overview of South Campus Master Framework and the MD Anderson Vision

Appendix H Urban Planning South Campus

Research at MD Anderson

Research fuels our mission to end cancer.

Many of the greatest minds in cancer research are at MD Anderson. They're here because MD Anderson offers a **unique environment** that accelerates their ability to end cancer. They collaborate with other cancer experts – in different research areas and with the world's leading cancer doctors. Bright students and trainees contribute further to our dynamic research environment.

Discoveries are fueled by vast research support and resources. Tomorrow's medicine is available to our patients first since we have the most cancer clinical trials in the world. These research efforts work in parallel to fight cancer through prevention, early diagnosis, effective therapies and scientific breakthroughs.

Moon Shot Programs

Cancer ends here. We're tackling cancer with a new plan — one that aims to improve cancer prevention, early detection and treatment. Our platforms, the research engines fueling the projects, are supporting us along the way, and **innovation, collaboration and scale get us there faster.** They give us the framework we need for success and speed up development for new and more effective care. It's bold. But **boldness brings progress.**

- MD Anderson Research Center

Our mission is to end cancer in Texas, the nation and world. Accomplishing that mission requires brilliance, creativity, commitment, excellence, passion and drive.

- MD Anderson Research Center



Building a Community of Campuses

As MD Anderson continues to evolve into the future, the collection of campuses that comprise the heart of the MD Anderson enterprise are intended to compliment one another and encourage interaction, access, and exchange amongst the larger community of campuses. North, Mid, TMC3 and South Campus Research Center will begin to share common organizational and planning goals that will distinguish the overall MD Anderson community with a common language of high connectivity, ease of use, and with a health and wellness focus.

South Campus Research Center will be an important destination for researchers within the community of MD Anderson, as well as a destination for researchers and academics from around the world. In addition, with the construction of the adjacent TMC3, access to partner organizations, as well as expanded access to industry innovation will be within walking distance of this new research campus.

Ease of use for vehicles and pedestrians is an important component of connectivity for all MD Anderson campuses. Providing opportunities for walking paths that interconnect campuses, convenient, easy to use vehicular drop-off points, as well as amenities and program uses that encourage cross-campus exchange are important considerations for the evolution of North Campus, Mid Campus, TMC3, and South Campus Research Center.

North Campus – TMC³ – South Campus Common Themes and Goals Among Campuses

- Grand focal point and center for each campus
- Experiential journey extending from North, Mid and TMC³ campuses to South Campus
- Connectivity, diversity, and quality of place amongst all campuses
- Complimentary programs and amenities that encourage cross-campus use
- Green spaces used as organizing elements
- Buildings define street edge
- Buildings define interior campus edge
- Campuses are inwardly focused
- Campuses provide high connectivity and ease of use
- Shared public functions located at pedestrian floors
- Outdoor zones create viewpoints and visual connections

1. Introduction - South Campus Master Framework Process

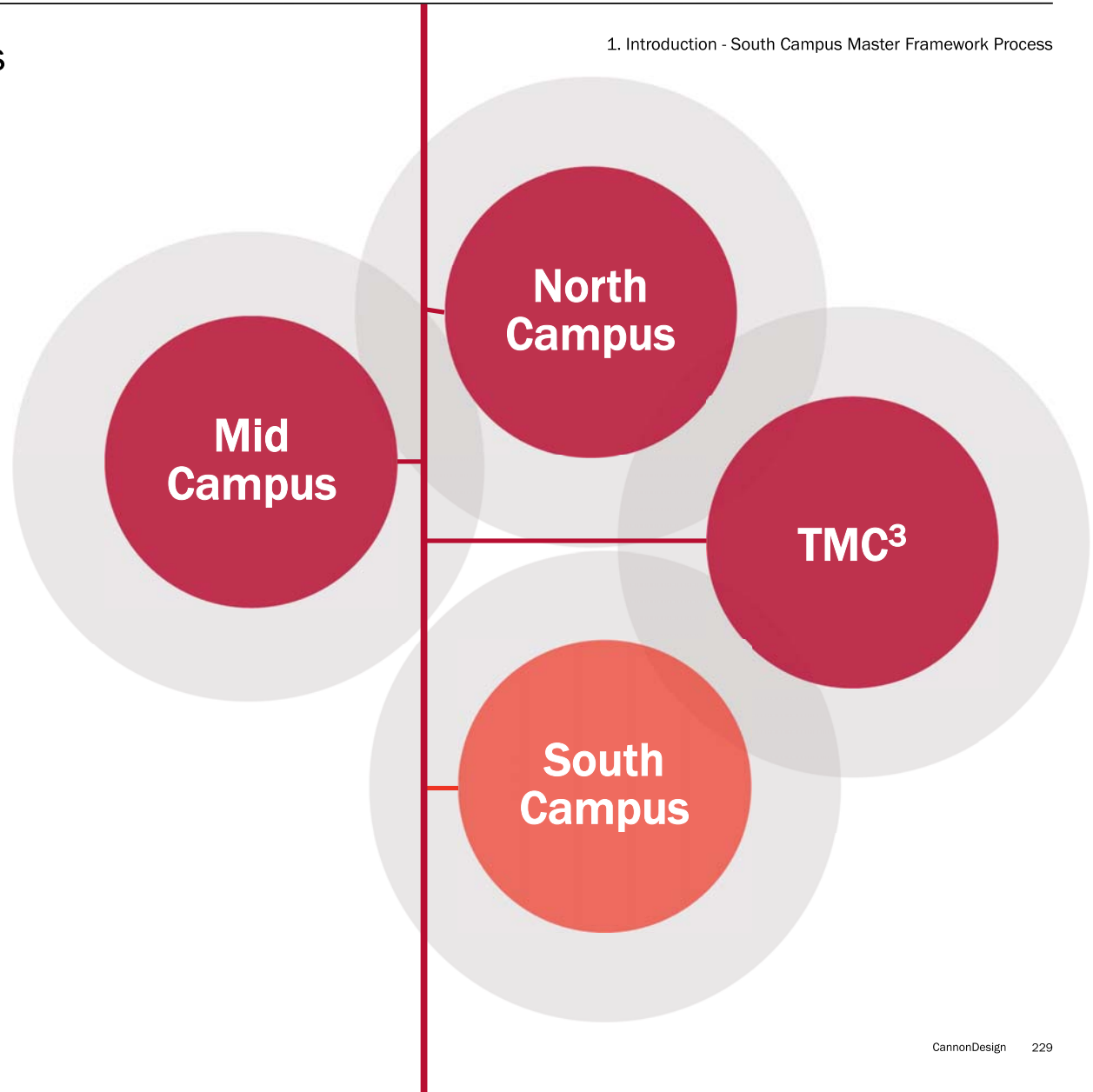

Future South Campus Research Center

MD Anderson is on a transformational journey to develop a focused research and academic campus that consolidates many of the existing research facilities currently distributed at various locations on the North Campus, while also providing new collaborative, state-of-the-art environments for upcoming and future programs. One of the primary goals of this new, focused research facility is to consolidate teams within the framework of a single research center that will provide dynamic, interactive space where researchers can collaborate and develop ideas in new ways, creating opportunities within groups that were previously not possible given the distribution and distance of resources, facilities, and teams. The master framework vision includes a rethinking of how research facilities currently work and function to deliver a future-minded campus environment intended to foster creative synergies between research and academics.

The South Campus is currently comprised of 13 buildings distributed across an approximately 90-acre site. The campus has evolved over an approximately 25-year time frame to respond to functional demands, rather than a collective vision, with the campus currently serving researchers, academics, and patients. The reimagining of this campus includes retaining many of the buildings that are currently on-site, bringing them into a more comprehensive, cohesive environment where researchers and academia can exchange ideas, to foster high connectivity within this environment.

As part of the master framework process, stakeholders from both MD Anderson and the UTHealth were engaged in the study of a variety of organizational models for the campus, intended to facilitate decisions about how researchers of the future will work and collaborate. The result of this effort generated a campus vision fueled by a new research campus typology.

The campus is designed to be inclusive on a variety of different scales.

1. City

The South Campus is considered part of the larger, collection of campuses for MD Anderson. With the North Campus and Mid Campus to the immediate north, it was important to consider connectivity at the city scale. Creating appropriate, easy-to-navigate opportunities to receive colleagues and materials was important to the design. One way this will be achieved is with a new arrival hub in the heart of campus, intended as an easy central point of connection, and will streamline the navigation for other collaborators arriving at the site.

2. Neighborhood

The campus is bounded by a variety of neighbors, and the design of the campus reflects this variety. To the north of the campus will be the new TMC3 campus, designed as an innovation hub where research and industry will merge with teaming at its core. The TMC3 campus will be comprised of mid-rise buildings, all designed around one collective, outdoor zone. The South Campus will serve as a termination point for the TMC3 axis, landing at the main central piazza of the new campus, and will be linked with an elevated bridge to physically connect the two campuses together. This will create opportunities for partnering synergies, as well as access for shared events between the two campus communities. It is also intended that this north side of the campus responds to the mid-rise scale that occurs along Old Spanish Trail, offering taller buildings that respond to both TMC3 and the surroundings.

To the south and east of the campus are portions of the UTHealth residential community. The southern edge of the campus lies

Immediately adjacent to this community. At the edge of the property lies a child development center, as well as a community recreational center that offer immediate adjacency to the campus. It is the intent of the new South Campus Research Master Plan to embrace this connectivity to its neighbors and offer inclusivity. Buildings on the south side of the site are intended to be lower in scale to those at the north end of the site, in order to better respond to the neighboring residential community

One of the primary goals of this plan is to create an 'open' campus environment, full of amenities and resources that encourage teams to use facilities in new ways. The research campus is designed to include a variety of evening and weekend uses intended to create a thriving, active, high-impact environment for researchers and community. The south side of campus is designed to engage this local community with recreational resources and a park-like setting that is active and vibrant.

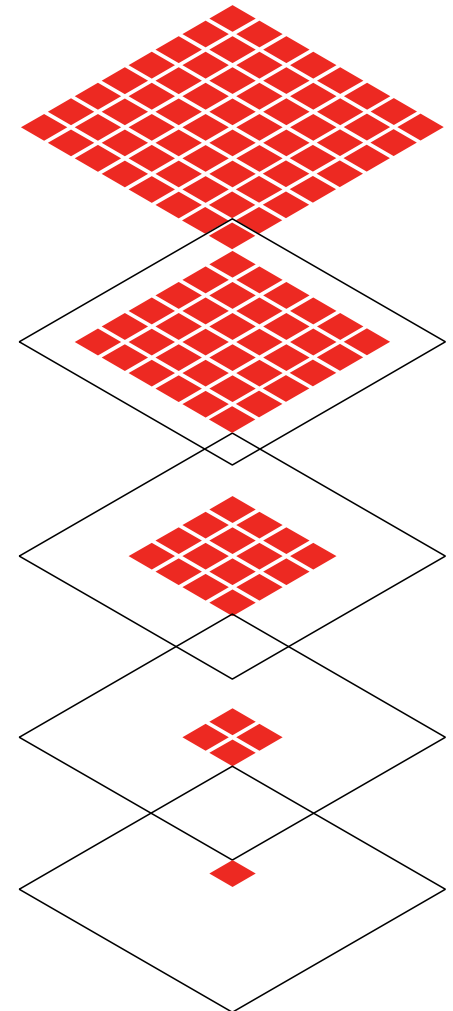

South Campus Master Framework Process

1. Introduction - South Campus Master Framework Process

3. Campus

At the core of the plan, this new campus is centered around a highly walkable, open, shared 'academic campus' model. The organizational fabric includes connectivity of the campus, both north-to-south, and east-to-west, across the entire campus, building a highly organized approach that allows one to experience a journey that includes a rich and varied set of experiences as one traverses the campus.

From north-to-south the campus is framed by a grand central piazza that serves as the gateway to the campus, and the terminus point for the TMC3 campus. This central piazza is connected to a large research quad, rich with amenities and a variety of experiences including retail, conferencing, food service, and activated ground floors at adjacent buildings designed to activate the open park-like quad area of campus. This quad is anchored on the north by a large central park that continues the north-to-south axis to the far south end of campus. When traversing this north-south path, the experience is varied, moving from large community space, to contemplative, meditative space, within the central park, and with connectivity at the south that offers varied recreational activities that may include running track, strength training, cycling path and/or other recreational amenities.

The organization of the campus from east-to-west works to foster connectivity amongst existing and new buildings, sharing outdoor space, as well as a large, grand canopy that connects and organizes the site in the east-west direction. Along this east-west axis the existing UTHealth buildings and the new East Parking Garage anchor the eastern edge of the site. Along the central portion of the east-west spine, the existing SCRB 3 and 4 buildings sit linked to the grand canopy and central heart of the new quad, along with the new SCRB5 and Education Building. At the far west, SCRB 1 and 2 anchor the west edge of the quad and receive the grand canopy that connects the site.

4. Building

Buildings throughout the campus are clustered around open areas, all including programs that are unique to the building types they surround. Ground floors of buildings are intended to be designed with active, shared space that offer activated outdoor environments to surround them. A focus on health and wellness, natural daylight, and fresh air are at the core of these open, shared spaces.

5. Individual

The campus will be highly walkable and filled with a variety of amenities, with the individual at the center of this model. Providing environments where researchers and community can thrive includes a variety of experiences that anticipate ways to build creativity, collaboration, and foster a healthful and vibrant MD Anderson community.

The master plan is comprised of a 5, 15, and 30-year planning approach. Each phase of the design includes the development of outdoor areas, amenities, and support that allow for each phase of the development to be comprehensive, resulting in a fully functional, robust, active campus in every stage of the South Campus Research Center's development.

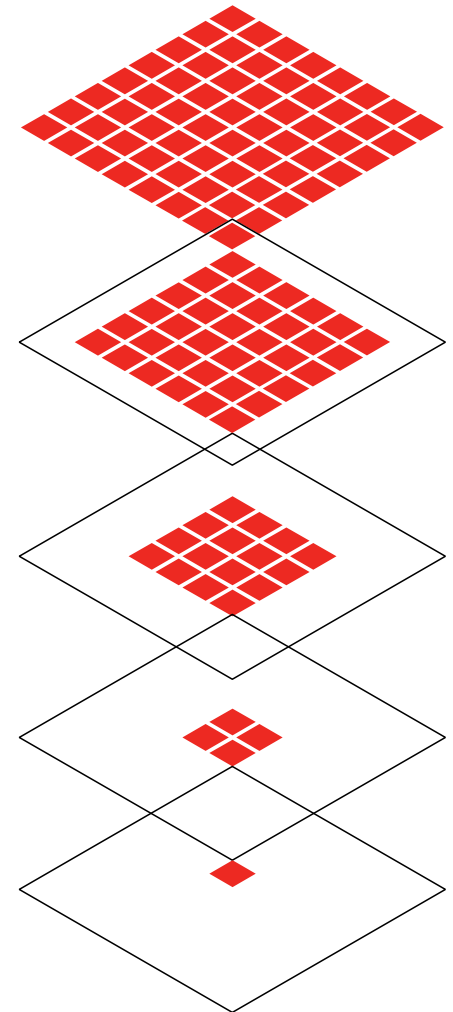

South Campus Master Plan Goals

1. Introduction - South Campus Master Framework Process



Focus on the creation of a 'research and academic community' that promotes and strengthens collaboration amongst MD Anderson research, Texas Medical Center, and other multi-institutional partners



Become 'the' MD Anderson research hub



Create a state-of-the-art destination that attracts an international team of experts

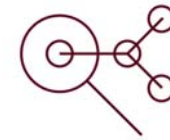

Provide facilities that enable high quality science, including sufficient animal space and core facilities



Become an incubator and accelerator for start up research



Create connectivity, diversity, and quality of place to generate the vitality and innovative research this community demands



Enable high connectivity



Link North and South campuses together using an interconnected language of programs and environments, with South Campus translational research being driven by North Campus clinical trials

Key Attributes of the South Campus Research Center

1. Introduction - South Campus Master Framework Process

Provide transportation and pedestrian connectivity that links North, Mid, and TMC3 campuses to the South Campus via Bertner as well as consideration of bridges from South Campus to North Campus

Provide a comprehensive campus that is fully realized at each phase

Provide complimentary amenities and access to TMC3 and the UTHealth residential zones that encourage cross-campus synergies

Enable high connectivity within the research center environment through transparent, activated ground floors, outdoor collaboration zones, and pedestrian friendly access that includes a variety of cross-campus resources

Provide a highly walkable environment, with a campus like feel

Create strong organizational elements within the campus environment

Envision a healthy, diverse campus with a variety of experiences, ample outdoor and green space opportunities

Provide visual and physical connectors between buildings allowing for cross disciplinary investigation via grade level shaded walkways

Enable the free flow ideas through diverse spaces and places for connection

Provide common assembly spaces that offer prominent, recognizable public space

Provide amenities for a high quality of life that includes evening and weekend opportunities on campus

Demonstrate environmental sustainability that promotes health and wellness

Appendix H
South Campus Master Framework

Urban Planning



South Campus 2021

2. Analyze - Existing Campus Configuration

The existing MD Anderson South Campus Research Center today features a partially developed, approximately 90-acre campus, that serves both researchers and patients. The campus also shares property with UTHealth and includes several UT buildings at Cambridge Street and East Road.

- A** SCRB 1/SCRB 2 (2002/2005) Immune Systems Science
- B** SCRB 3/SCRB 4 (2008/2010) Imaging and Disease Genetics
- C1** Physical Plant and UT Police Department
- C2** Smith Research Building
- C3** Modular Labs
- D** Proton Therapy Center 1
- E** Proton Therapy Center 2 (2021)
- F** Parking Garage
- G** Central Utility Plant (CUP)
- H** Operations and Maintenance Storage
- J** Hazardous Waste Storage
- K** Water Well
- L** UTHealth - Conference Center
- M** UTHealth - School of Dentistry
- N** UTHealth - Behavioral Health and Biomedical Sciences
- P** UTHealth - Central Utility Plant
- Q** UTHealth Child Development Center
- R** UTHealth Maintenance Facility

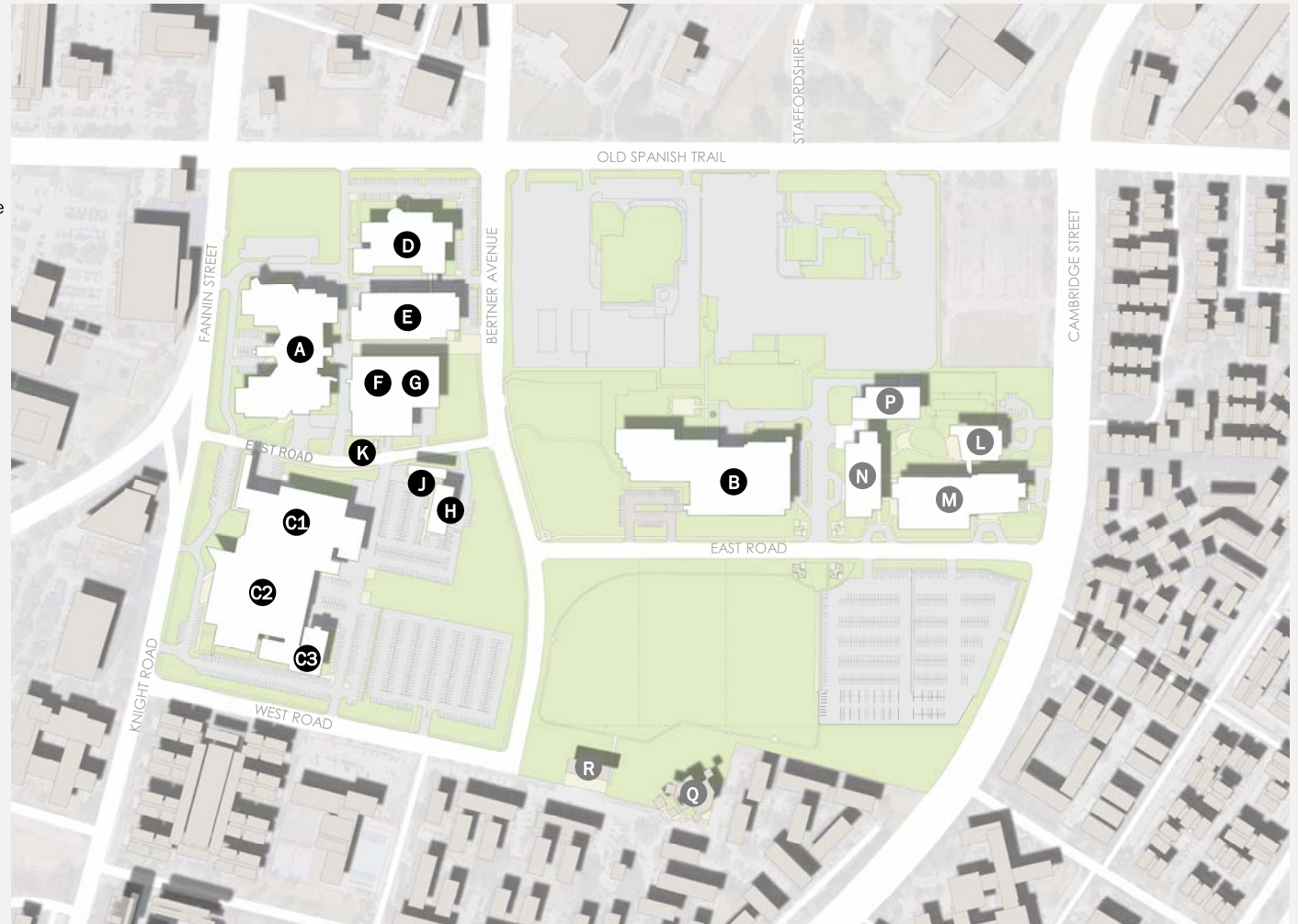

Existing Campus Site Analysis

2. Analyze - Existing Campus Site Analysis

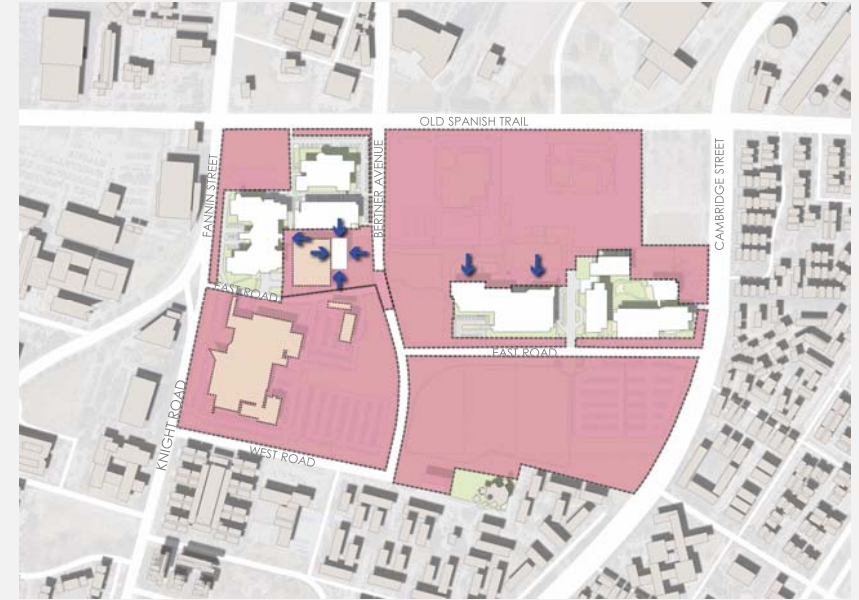

Campus Context and Adjacencies

- Future TMC³ Campus will be located immediately north of the South Campus
- Mid rise buildings planned at TMC³ Campus and Old Spanish Trail
- UTHealth Residential located to south and east of the South Campus
- UTHealth Child Development Center located at south edge of campus and immediately adjacent to residential area
- Recreational Center located along West Road just south of South Campus
- Child Development Center located south of field areas along south side of site
- Lower scale residential buildings located to the south and east of the campus site

Development Zones

- Existing buildings to remain include SCRB 1 and 2, SCRB 3 and 4, all UTHealth Buildings, Proton Therapy Center 1 and 2, Central Utility Plant, and Water Well Building
- Limited surface parking will be retained and includes drop-off areas and service access to SCRB 1 and 2, SCRB 3 and 4, and Proton Therapy Center 1
- Existing campus buildings scheduled for demolition in a phased approach and within the new development zone will include Smith Research Building Complex, Hazardous Waste Building, Operations and Maintenance Building, and the Parking Structure adjacent to the Central Utility Plant
- Recommended exterior upgrades to Central Utility Plant, SCRB 1 and 2, and SCRB 3 and 4, as these are areas that will engage new master framework outdoor environments

Existing Campus Site Analysis

2. Analyze - Existing Campus Site Analysis

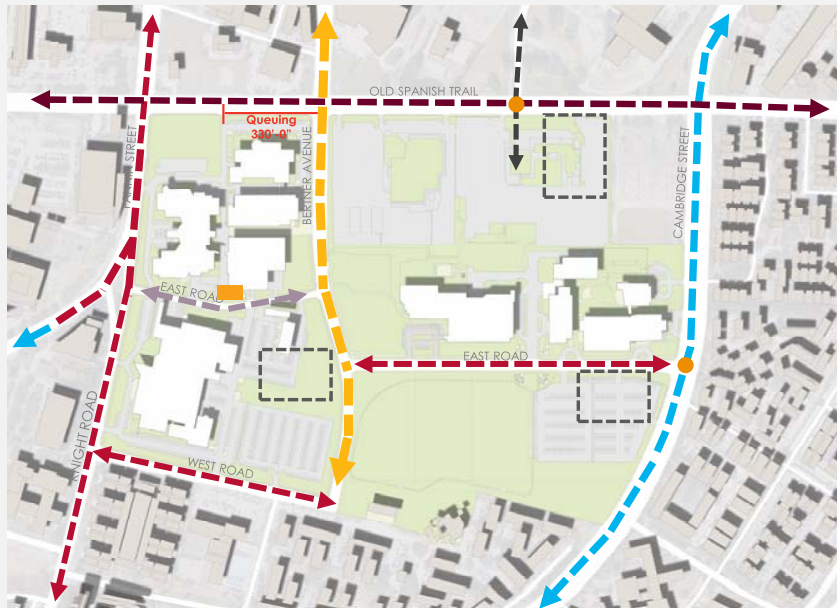

- Primary Access Route Between North, Mid, and South Campus
- Main Artery
- Secondary Artery
- Tertiary Artery
- Anticipated MD Anderson North, TMC³, South Campus Access
- Planned New Traffic Light
- Preferred Zones for Future Parking Structures
- Existing City Utilities - Main Trunk Lines
- Utility Corridor
- Emergency Power
- Natural Gas
- Chilled Water Lines
- Central Utility Plant (CUP)
- Water Well

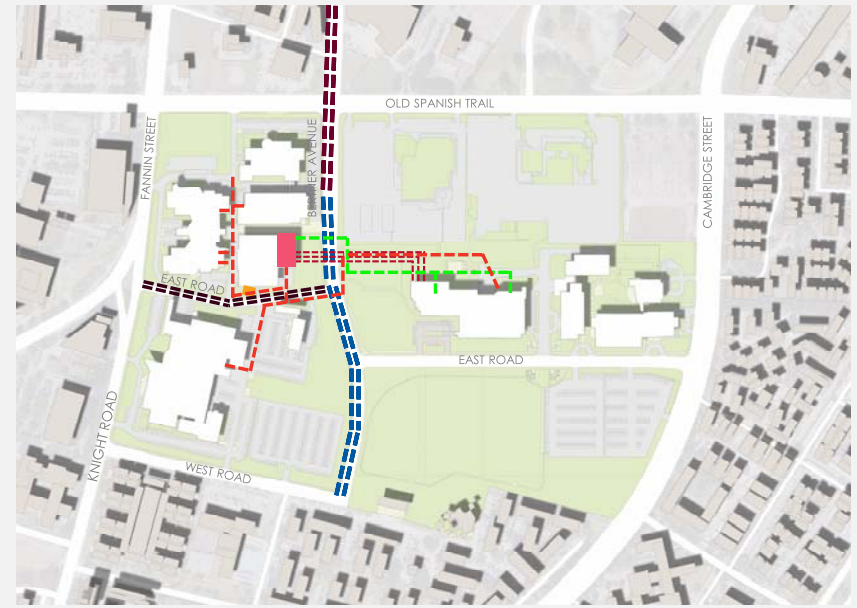

Utilities and Infrastructure

- Maintain main utility corridor located along Bertner Avenue
- Provide continued access to utility corridor located along East Road between Fannin Street and Bertner Avenue
- Water Well located along East Road must be protected in place and provided with consistent pull-up 18-wheeler access and thoroughfare between Fannin Street and Bertner Avenue
- CUP located along Bertner Avenue to be protected in place

Vehicular Circulation and Traffic

- Bertner Avenue serves as main connector between North, Mid, and South Campus
- Old Spanish Trail represents primary artery access route
- New Staffordshire Road extension will connect North Campus and TMC³ to South Campus for access to parking
- Limit traffic/protect pedestrian safety between UTHealth buildings along East Road and parking
- Limit future interior campus surface parking to create a "campus like feel"
- Future campus will include retractable bollards along Bertner Avenue at East Road to deter commuter traffic through site
- Future animal movement will be via service vehicle (feasibility via below ground tunnels or above ground bridges determined not cost effective)
- Locate parking structures at periphery of site to prioritize a walking, experiential environment

BIG VISION

Bringing together previously separate research and academic groups into a single, highly flexible campus environment designed to create a cohesive umbrella where medical professionals, global experts, and industry partners can collaborate and work together as dynamic, multi-disciplinary teams to fuel cancer research discovery and drive future innovation

New Campus Characteristics

3. Synthesize - Design for a New Research Campus



Strong variety of experience
(Retail, Housing, Service, Industry)



Activated ground floors



Defined pedestrian pathways with emphasis on walkability



Defined public green space

Creating a transformative environment for this new research campus focuses on community, connectivity, collaborative space, and environments that support the wide range of research, academics, and social engagement that will occur on campus.

With ideas built around an academic, highly walkable community-based campus, the South Campus offers a very new kind of transparency of space, place, and engagement with local community that is not common to research campuses. The intentional design for an active, vital community will rely on a variety of environments that engage and reinvent how work/life balance may be supported by an active campus environment.

Activated ground floors, programmed event space, relaxation space, meditative and contemplative space, as well as recreational and sports spaces, library, retail, and restaurants, all centered around new research buildings, vivarium, and academic buildings, will create new synergies where individuals can thrive in new places and in new ways.

Stakeholders in the master plan process identified these characteristics that are important to consider when designing environments for this new, innovative research campus. Fostering a truly interactive, campus environment will rely on these characteristics to generate the kind of change that this model for campus design will require.

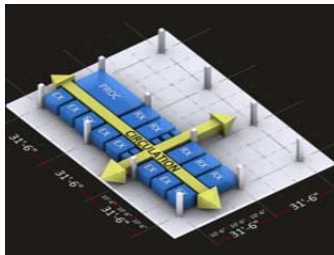

Large floor plates with flexible plan



Responds to the larger community of programs and spaces



Fosters informal interactions



Uses quads, walkways and courts as organizing elements



Increases opportunities for casual collaboration with all under one roof



All buildings perceived as a collective whole providing a sense of community



Focus on human scale

A campus driven by connectivity and quality of place to form a community

Mobilization Phase

Phase Description

- A Operations and Maintenance moves to Smith Research Building (SRB)
- B Hazardous Waste Storage either relocates or constructs new structure north of SRB Complex
- C Water Well to remain with access from both East Road and Bertner Avenue (Access from Arrival HUB. Refer to “5 Year Master Framework” Plan and “5 Year Phasing Components – Arrival HUB and East Road Modifications” for additional details)
- D Buildings to remain operational as currently existing
- E PTC2 under construction. Site design for PTC2 to be modified to accommodate the shaded canopy planned as a connector for SCR1 and 2 from East Parking Garage. Portion of connector to be removable, refer to item 9 under Components for 5 year phasing. Site design for PTC2 to be modified to remove detention area planned adjacent to Central Utility Plant to accommodate new Arrival Hub.
- F Propane tanks for shuttle refueling to be relocated to East Campus
- G Shuttle service to be relocated to East Campus
- H Surface parking to be reconfigured / relocated to allow start of construction for East Parking Garage
- I Detention pond to be relocated (or to remain) in new campus and landscaping development. (Refer to Civil Analysis for further details)

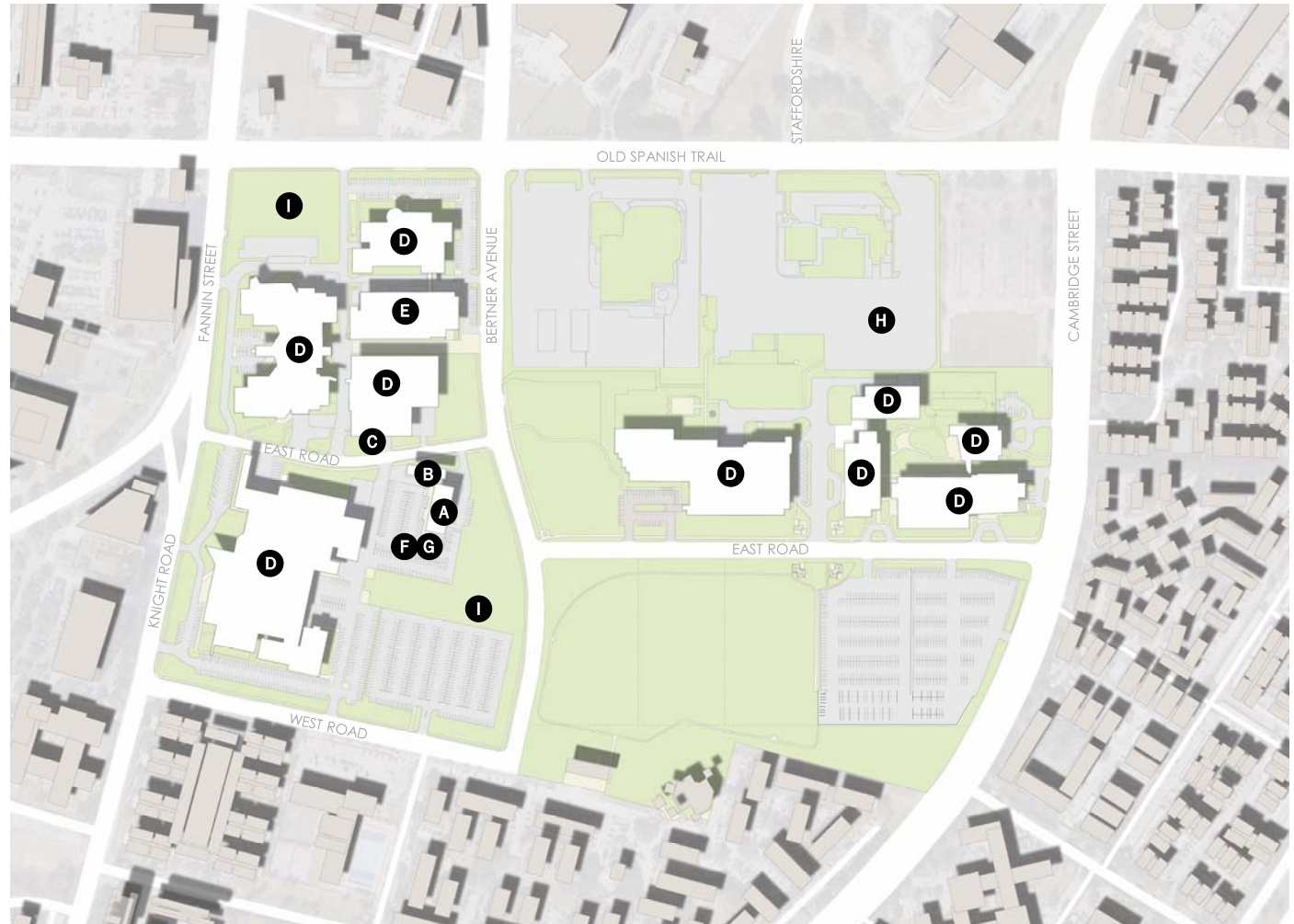

5 Year Master Framework

4. Visualize - 5 Year Master Framework



Planned growth within the 5 year time frame focuses along the north side of the campus and includes development along Old Spanish Trail. Along with the construction of a new East Parking Garage and Staffordshire Road extension, a new SCR5 Building, MD Anderson Education Building, and UTHealth Education Building, are included and are centered around a new grand, central piazza, featured prominently along Old Spanish Trail. The central piazza will connect the new South Campus with the new TMC3 campus via a new elevated bridge over Old Spanish Trail. In addition, the integration of a new Vivarium Building is featured prominently along Bertner Avenue. Addition of Radiation Physics to SCR3 will add new building mass to the south side of this existing building.

A new central arrival hub has been located adjacent to the Vivarium Building and is designed to receive shuttles, buses, ride share vehicles, and other transit vehicles arriving from MD Anderson North and Mid Campus, as well as to support pedestrians crossing South Campus through the zone of the east-west quad, under shaded canopies.

A new central park will commence construction during this first phase of development. The park will run adjacent to Bertner Avenue and will terminate near SCR3 and 4 Buildings. This central park will link TMC3 and the north side of South Campus to East Road. The final build-out of the central park will extend all the way to the south side of the property linking the campus north to south in the final phase of the master plan. This central park will provide a lushly vegetated, park-like setting along the main central spine of the campus along Bertner Road.

The east and west sides of campus are provided with a new central research quad that reaches from the far east to the far west sides of campus, connecting existing buildings SCR1 and 2, Proton Therapy Center 1 and 2, SCR3 and 4 and UTHealth Buildings with the central heart of the campus. The new quad features prominently in the campus design and includes amenity buildings within a park-like setting, as well as a grand, central canopy at the heart of the quad, intended for outdoor dining, relaxation, meeting space, touch-down space and other features.

New SCR5, MD Anderson Education Building, and the UTHealth Education Buildings all include active ground floors that maximize indoor-outdoor access. A new canopy element running east to west, will create a central connector spine across the campus, intended for ease of access during hot days and inclement weather.

5 Year Master Framework

4. Visualize - 5 Year Master Framework

MD ANDERSON

	Footprint	GSF
1 East Parking Garage	60,000 SF	360,000
2 SCRB 5	95,000 SF	600,000
3 Vivarium	60,000 SF	450,000
4 MD Anderson Education	35,000 SF	350,000
5 Main Piazza	-----	3.4 Acres
6 Bridge to TMC3	-----	-----
7 Research - Main Quad	-----	5.6 Acres
8 Conference + Amenity	10,000 SF	40,000
9 Central Park (Partial)	-----	2.1 Acres
10 Arrival Hub	-----	-----
11 Grand Canopy	-----	-----
12 Shaded Canopy	-----	-----
13 Optional - New Surface Lot (~200 cars)	-----	-----
14 Radiations Physics Expansion to SCR3	10,000	10,000
15 Temp. Hazardous Facility	10,000	10,000

UT HEALTH

	Footprint	GSF
16 UTHHealth Education	-----	300,000

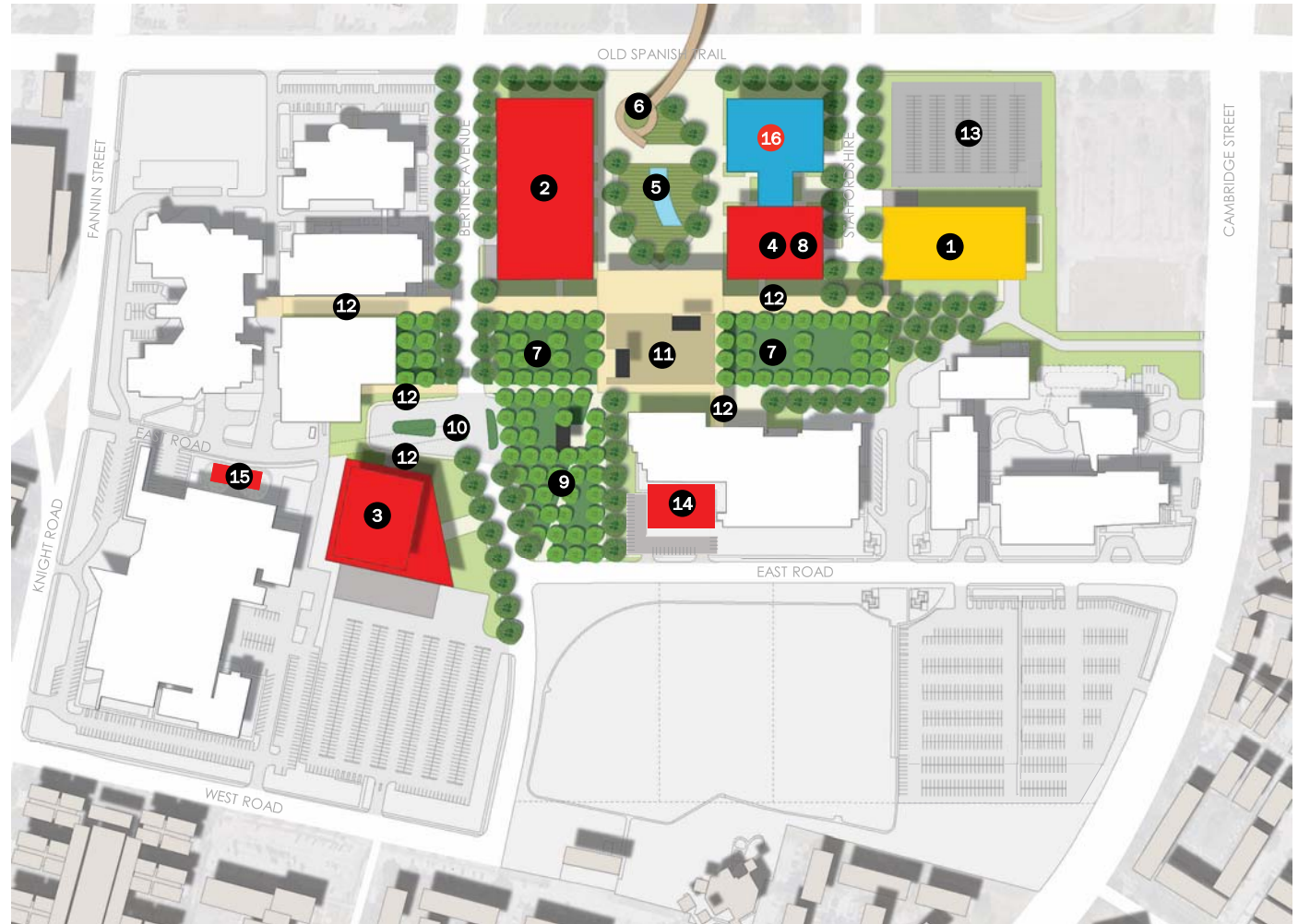

5 Year Phasing Components

4. Visualize - 5 Year Phasing Components

1. Building Demolition – Hazardous Waste Building and Operations and Maintenance Building

- Demolish Hazardous Waste Building (B) and Operations and Maintenance Building (A) (refer to Mobilization Phase diagram)
- Hazardous waste will be relocated, or a new facility built north of SRB Complex. New Hazardous Waste Building's permanent location will be at the West Parking Garage indicated in the 15-year plan
- Operations and Maintenance will be provided short-term space in the Smith Research Building, until buildout and relocation to the West Parking Garage in the 15-year phasing plan, where Operations and Maintenance will permanently reside

2. East Parking Garage

- Complete Staffordshire Road extension to provide primary garage entry/exit from Old Spanish Trail
- Build new East Parking Garage with primary entry/exit from new Staffordshire roadway expansion onto South Campus site
- Provide secondary entry/exit on south side of garage from Cambridge Street (entry/exit will be accessed from southbound side of roadway only, as median separates northbound traffic)
- Provide alternate secondary “entry only” access to garage from East Road with limited access to deter vehicular traffic on East Road for pedestrian safety (Refer to Parking and Traffic Studies for additional enhancements required)
- Locate normal/emergency power switchgear equipment inside new garage, including outdoor service zone, roadway access, pull-up/turn-around for CenterPoint service vehicle access
- Provide landscaping and site improvements at building perimeter, as well as canopy at south side of garage to connect to main east-west quad
- Consider location of primary vertical circulation to the west side of garage, close to the new buildings in the first phase

3. MD Anderson Education Building

- Build new Education Building, located adjacent to the UTHealth Education Building, and immediately adjacent to Main Piazza
- Inclusion of conference center and retail food service are considerations for this building program
- Main service entrance and dock Area for Education Building to have access from Staffordshire
- Build sitework/landscape connectivity between MD Anderson Education, SCR5, and UTHealth Education Building

4. SCR5 and Vivarium Buildings

- Build new SCR5 building located along Old Spanish Trail at Bertner Avenue
- Primary building entrances to be provided along the Main Piazza, as well as along Bertner Avenue
- Main service entrance and dock area for SCR5 to be located below grade with access from Bertner Avenue
- Relocate existing detention pond on site – refer to Civil Study
- Build new Vivarium Building
- Primary entrance to Vivarium to be located adjacent to Arrival Hub with canopied access to building
- Main service entrance to Vivarium to be provided from Bertner Avenue, and includes a full-service dock, vet med service/ small vehicle delivery/drop-off zone, as well as service vehicle parking zone for 10-12 vehicles
- Animal transport to/from Vivarium will occur via service vehicles and will utilize the dock and service entrance off of Bertner Avenue
- Vivarium will serve as a destination point for animals, and movement will be limited (no tunnels or above ground bridges will be utilized for animal movement on campus as determined not cost effective)

5. Arrival HUB and East Road Modifications

- Construct new Arrival Hub loop along Bertner Avenue south of Proton Therapy Center 2 and adjacent to Central Utility Plant
- Arrival Hub will serve to deter traffic through the center of campus and will provide a central vehicular drop-off/pick-up point, including access for MD Anderson shuttles serving North and Mid Campus, rideshare vehicles and bicycles
- Arrival Hub will provide canopied and shaded areas to connect hub to Vivarium and other pedestrian access routes serving the campus
- Arrival Hub will include partial closure of East Road with termination of roadway adjacent to existing parking garage entrance
- Area of East Road closure will be designed as easement for continued utility service access
- Easement to be designed as a contiguous part of the greenbelt that connects the east-west Research Quad with the Vivarium and Arrival Hub
- Area of easement to utilize hardscape and landscape features, landscape pavers, and other elements, to blend into the surroundings, while providing access for emergency service vehicles to drive from East Road through the easement area to access the Water Well Building and Bertner Avenue
- UTHealth will continue to use separate shuttle route on campus with direct access to UTHealth buildings on South Campus accessed from Cambridge Street and East Road due to walking distance from Arrival Hub
- Individual buildings site design to give considerations for bicycle parking as well as shuttle access to individual buildings in addition to the Arrival Hub

6. Central Utility Plant

- Provide new exterior upgrades and new exterior enclosure to areas of existing Central Utility Plant building to appropriately engage the adjacent quad area.

5 Year Phasing Components

4. Visualize - 5 Year Phasing Components

7. Radiation Physics Addition to SCRB3

- Addition of 3-5 radiation vaults to SCRB3
- These will be located on the south side of SCRB3 on the patient parking lot, with access from inside SCRB3
- The patient parking lot to be reconfigured and relocated to accommodate the expansion

8. Main Piazza and Bridge to TMC³

- Build all hardscape and landscape components for new Main Piazza and Grand Entry to the campus that will connect the new SCRB 5, MD Anderson Education Building, and UTHealth Education Building, creating a common shared open space and gateway destination for individuals arriving from TMC3
- Build connector bridge over Old Spanish Trail, connecting the TMC³ Campus with South Campus at the Main Piazza open area
- Bridge to provide sculptural, architectural expression that complements the architecture of both South Campus and the TMC3 campus
- Bridge to provide a minimum 14'-6" clearance over roadway and provide a minimum of 16' - 20' width to allow golf carts access simultaneously in both directions along with pedestrian walkways
- Considerations for elevators or ramping for ADA access to be given during design development of the bridge and the experience desired for the landscape area in the Main Piazza

9. Main Research Quad, Grand Canopy, and Covered Walkways

- Build new Main Research Quad adjacent to Main Piazza, extending east-west from East Parking Garage to SCRB 1 and 2, and connecting along the south to SCRB 3 and 4 and UTHealth existing buildings
- Build new Grand Canopy located at center of new Research Quad immediately adjacent to Main Piazza. The size of this Grand Canopy to be determined as the staff, student and visitor experience of the landscape in the Research Quad is developed, so as to complement the desired functions and experiences.
- Grand Canopy to provide central outdoor gathering area for campus with canopy providing shade and ambient conditions to serve a variety of functions
- Area under Grand Canopy to include programmed building space for food service, coffee / snack service, touch down commuter spaces for individuals as well as small groups, large group gathering space for outdoor conferencing, outdoor hoteling stations, as well as relaxation space and outdoor dining
- Grand Canopy to also be designed to also host large events including open outdoor lectures, awards, music events, and other hosted functions
- Grand Canopy to include areas that are watertight as well as areas that are louvered to provide shade, while allowing access to natural light
- Build shaded walkways that connect Grand Canopy with East Parking Garage, MD Anderson & UTHealth Education Buildings, SCRB 5, SCRB 1 and 2, Proton Therapy Center 2, and SCRB 3 and 4
- Portion of new shaded walkway south of Proton Therapy Center 2 will be provided with removable canopy panels to provide access to equipment along south side of Proton Therapy Center 2 that requires crane and service access on south facade
- Upgrade Central Utility Plant with addition of new articulated facade treatments at north, south, and east elevations of plant that will engage the new Arrival Hub and Main Research Quad
- Upgrade north side of SCRB 3 and 4 to appropriately engage the new Grand Canopy and enhancements to shield dock area from view

10. Partial Construction of Central Park

- Build new Central Park area bounded by Bertner Avenue and East Road, and immediately adjacent to SCRB 1 and 2
- New Central Park to provide shaded, tree lined greenbelt along Bertner Avenue with park-like amenities that connect from north-to south across the site and provide a continuous pathway from the Main Piazza to East Road
- Central Park amenities will reside primarily along the east side of Bertner Avenue, however, the large tree-lined pathway that occurs along the roadway will also extend along the west side of Bertner Road, to create a dense, tree-lined canopy through the central heart of campus where bikes and pedestrians may pass through from the south residential side of campus through to the north side of campus

11. UTHealth Education Building

- UTHealth to construct new Education Building, with frontage along Old Spanish Trail, and immediately adjacent to the MD Anderson Education Building
- The building will feature prominently as a key contributor to the atmosphere and program areas of the Main Piazza to the Campus from TMC3 with activated ground floors and shared program elements participating in the pedestrian experience along the Main Piazza including areas to socialize, congregate, and collaborate
- Primary building entrance for the Education Building to be provided along west side of building facing Main Piazza to the campus
- Secondary entrances to the building to be provided along the south and east sides of the building,
- Main service entrance and dock area for the Education Building to be located along the east side of the building with ease of access to Staffordshire Road

Master Framework Schedule for 5 Year Plan

4. Visualize - 5 Year Master Framework

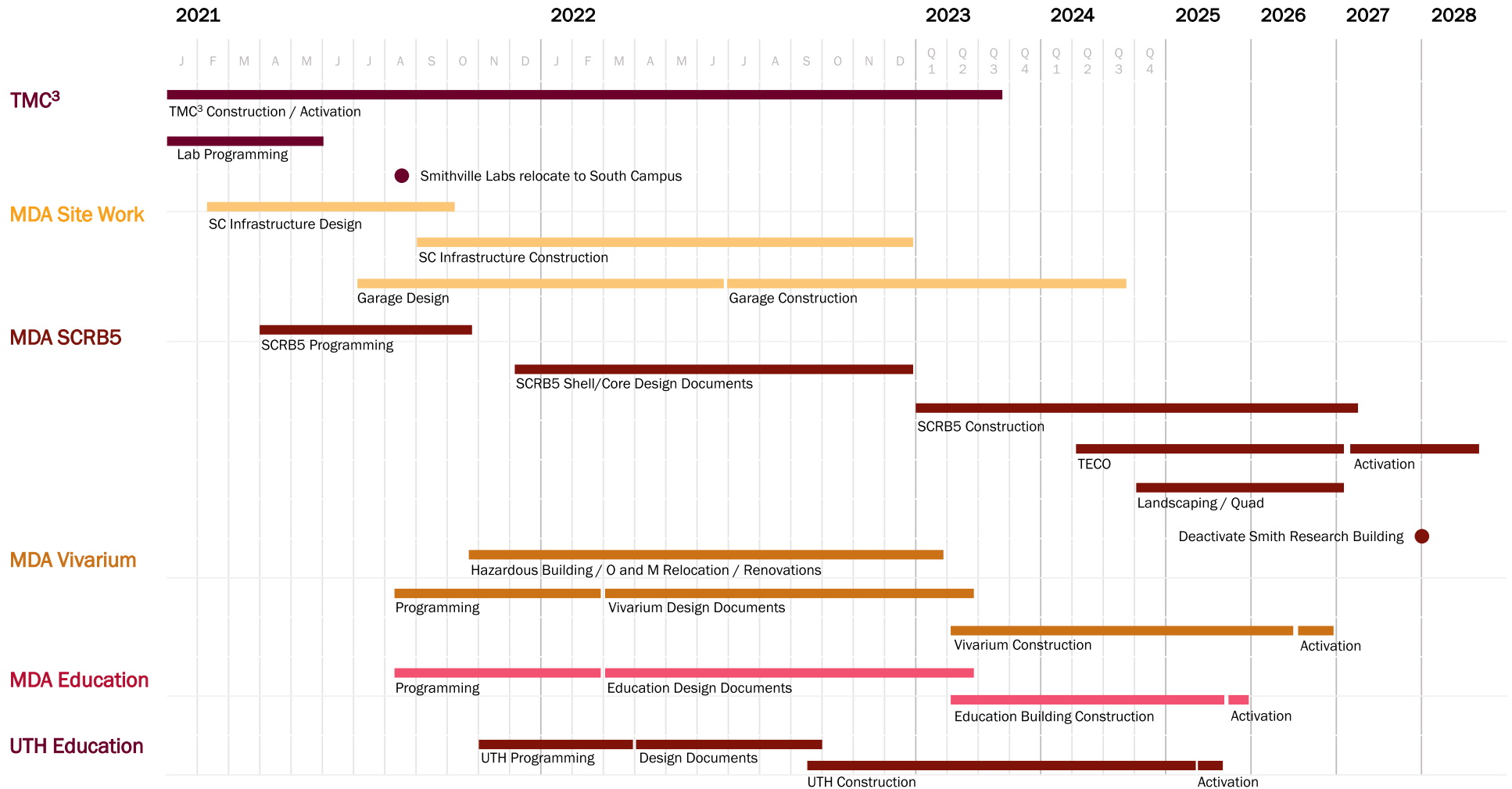

Existing South Campus

4. Visualize - 5 Year Phasing

Existing South Campus with Proton Therapy 2 building under construction

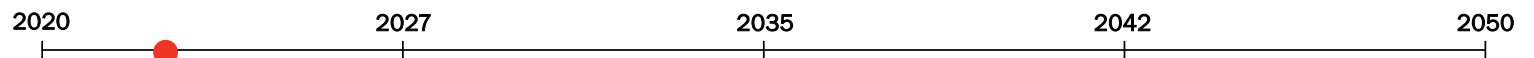

Phase 1

4. Visualize - 5 Year Phasing

Phase 1:

- East Parking Garage (refer to Parking Study for details)
- New Utilities (Refer to Civil, MEP and Technology Studies for details)

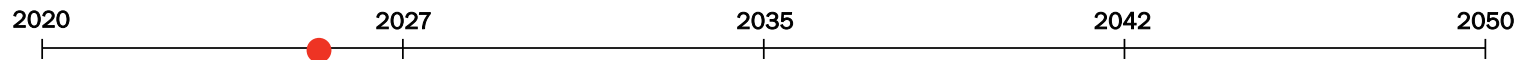
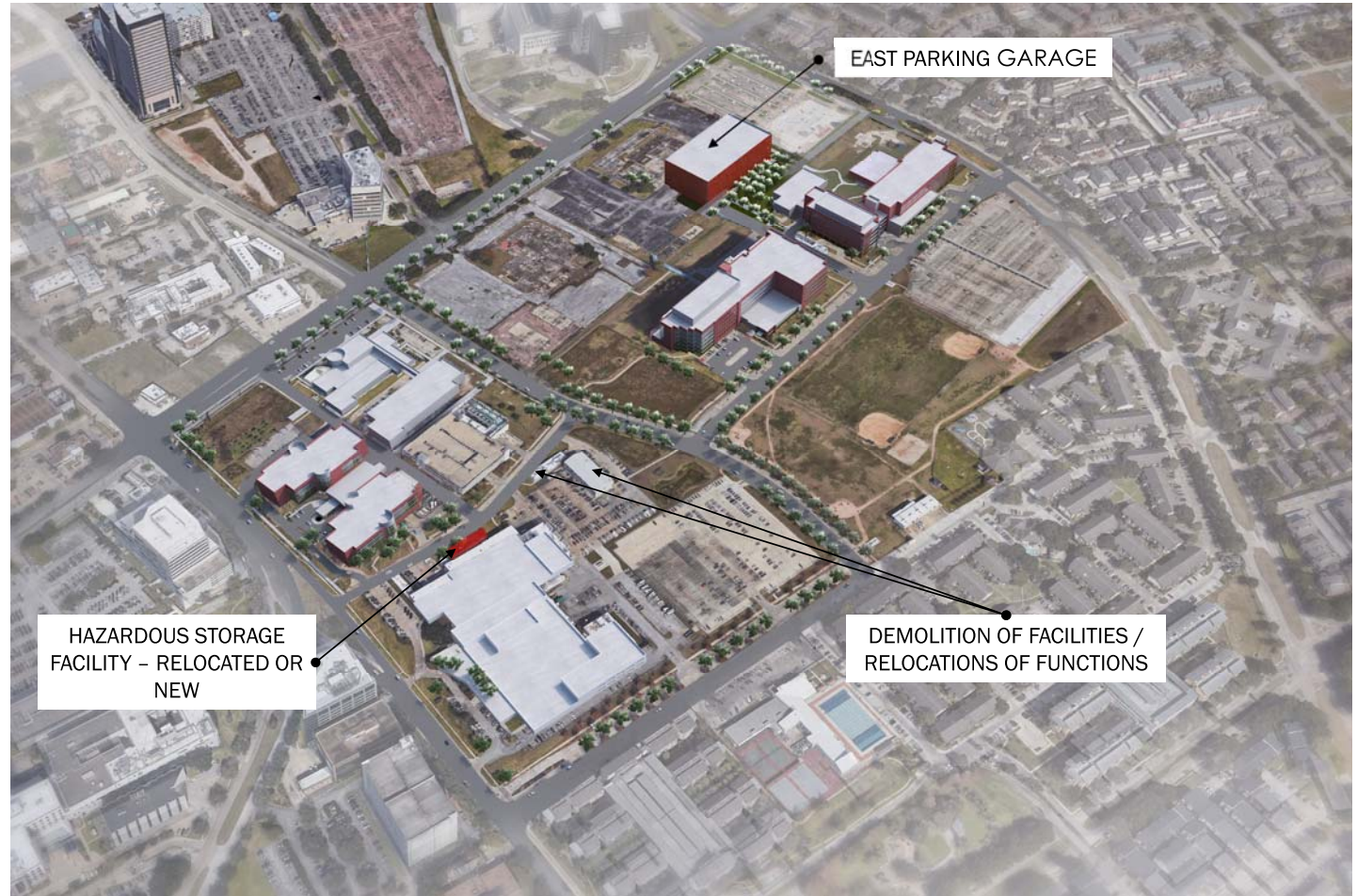

Phase 2

4. Visualize - 5 Year Phasing

Phase 1:

- Parking Garage (refer to Parking Study for details)
- New Utilities (Refer to Civil, MEP and Technology Studies for details)

Phase 2:

- Site Work and Landscaping
- Buildings Under Construction
 - Vivarium
 - SCR5
 - MD Anderson Education Building
 - UTHealth Education Building
 - Radiation Physics Expansion to SCR3

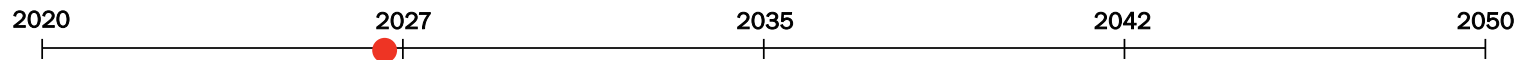

Phase 3

4. Visualize - 5 Year Phasing

Phase 1:

- Parking Garage (refer to Parking Study for details)
- New Utilities (Refer to Civil, MEP and Technology Studies for details)

Phase 2:

- Site Work and Landscaping
- Buildings Under Construction
 - Vivarium
 - SCR5
 - MD Anderson Education Building
 - UTHealth Education Building
 - Radiation Physics Expansion to SCR3

Phase 3:

- Buildings Completed
 - MDA Education Building
 - UTH Education Building
 - Radiation Physics Expansion to SCR3
- Buildings Under Construction
 - Vivarium Building
 - SCR5
 - Site Work and Landscaping

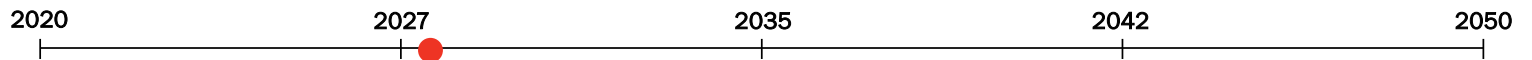

Phase 4

4. Visualize - 5 Year Phasing

Phase 1:

- Parking Garage (refer to Parking Study for details)
- New Utilities (Refer to Civil, MEP and Technology Studies for details)

Phase 2:

- Site Work and Landscaping
- Buildings Under Construction
 - Vivarium
 - SCR5
 - MD Anderson Education Building
 - UTH Health Education Building
 - Radiation Physics Expansion to SCR3

Phase 3:

- Buildings Completed
 - MDA Education Building
 - UTH Education Building
 - Radiation Physics Expansion to SCR3
- Buildings Under Construction
 - Vivarium Building
 - SCR5
 - Site Work and Landscaping

Phase 4:

- SCR5 and Vivarium Building Completion
- Campus Development for 5 Year Plan Complete

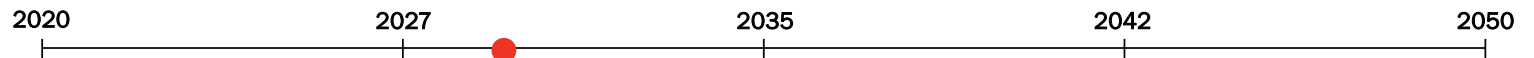



5 year plan, 3D View

Main Piazza / Grand Entry

4. Visualize - 5 Year Outdoor Environments and Open Areas



With a variety of outdoor environments on the South Campus, each individually is intended to both respond to, and offer up unique characteristics and attributes that serve to complement and extend the environments of adjacent buildings, and communities they serve.

The Main Piazza / Grand Entry to the South Campus represents the heart and soul of the campus entry gateway. The intention of this piazza is to connect a variety of users to this large, formal outdoor setting. Comprised of approximately 3.4 acres, this grand, central gathering space is anchored by the new SCR5, MD Anderson Education and UTHealth Education buildings. The first floors of these buildings will be programmed and designed with conferencing, retail, food service, and other amenities to activate the ground floors of these buildings, providing comprehensive indoor-outdoor environments that include socialization space, meeting, and touch-down space, all working together to activate the outdoor zone of the grand entry.

Another important aspect of this grand entry is its relationship to the street and the neighbors. Sited immediately adjacent to Old Spanish Trail, this public zone is further defined by its immediate adjacency and direct connection to the TMC3 campus via an elevated bridge over Old Spanish Trail. This public piazza area is the landing area for individuals and teams coming from the TMC3 campus for collaboration and shared use with the South Campus community. Building this relationship with the TMC3 campus will provide opportunities to further enrich the research and academic arms of South Campus.

Amenities may include:

- Large pre- / post-function space
- Open area conferencing and collaboration
- Performance and lecture space
- Award and ceremonial space
- Community event space

Key Attributes

- Large public plaza with grand central gathering area
- Heart of campus entrance gateway
- Landing pad for bridge from TMC³
- Main receiving point for teams arriving from TMC3 campus
- Complimentary environments and amenities to TMC³
- Enriched, formal outdoor entrance to campus

At the heart of this vibrant community are environments designed to bring together previously separate groups into a shared collaborative environment, creating spaces, and places where new synergies can emerge and thrive

Main East-West Research Quad

4. Visualize - 5 Year Outdoor Environments and Open Areas

Outdoor environments, landscape, hardscape, and amenity spaces form the connective tissue between buildings, support communities, and bring health and wellness to the forefront of this walking campus

Research main quad is the primary connector that weaves together existing MD Anderson and UTHealth South Campus buildings with the fabric of the new campus. The quad environment connects the campus in the east-west direction across the entire site, bringing the existing SCR B 1 and 2 building into a connected, walking, outdoor environment. Similarly, the main quad connects a portion of the campus in the north-south direction, acting as a main community space at the center of campus. To the north of the main quad sits the grand entry, and to south are the SCR B 3 and 4 buildings, along with UTHealth existing facilities and outdoor recreational space.

The research main quad is large, at approximately 7.3 acres, and is intended as a place filled with diverse spaces and places, including a large central grand canopy, which will serve as an ambient, outdoor covered area designed to include event spaces, coffee bar areas, dining areas, retail, and gathering spaces. This area is the central meeting place on campus and should be thought of as a place to walk, connect,

decompress, share with others, meet in groups, read a book, have a concert - a place for activities large and small.

In addition to the environments created in this large outdoor quad area, it is important to create places that are shaded and comfortable. Shaded elements, such as the grand canopy and covered walkways will connect the campus in the east-west direction, from the East Parling Garage to SCR B 1 and 2 on the west, making it comfortable to cross the campus during any season.

The research main quad is bisected by Bertner Avenue and includes a new arrival hub that is integrated into the main quad design. This arrival hub is the main drop-off area on campus, as well as the primary connector area for individuals coming from North and Mid campus. The arrival hub will be well integrated into the overall research main quad, with shaded canopies and amenities within close proximity.

Key Attributes

- Central grand canopy and covered walkways that visually connect the existing campus buildings with the new
- Grand canopy filled with outdoor rooms offering a variety of program uses
- Diverse spaces and places that offer a variety in size, scale, and experience
- Gathering spaces connecting central core of research campus east-to-west
- Amenities that offer informal opportunities to connect, conference, and socialize outdoors

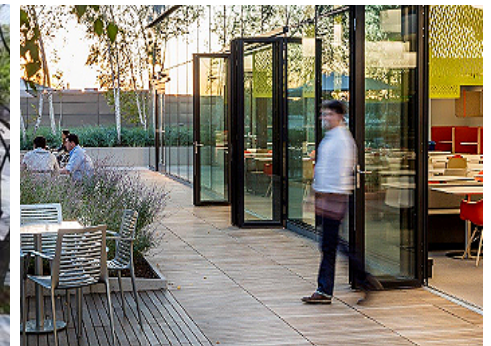



View of the Research Quad

Partial Development of Central Park

4. Visualize - 5 Year Outdoor Environments and Open Areas



The character and environment of the central park component of campus is special, unique, highly planted, recreational and contemplative. The space, landscape and destination is intended to feel distinctly different from other open areas on the campus.

Located adjacent to Bertner Road, the park offers a unique identity to the central part of the campus. Extending from Old Spanish Trail and SCR 5 and all the way down to West Road, with immediate adjacency to the UT residential community housing, the park is a place for outdoor meditation, yoga, a place to have lunch, read a book, stroll with co-workers, as well a place to pass through on a bike, a space to renew, refresh and replenish.

The area can be considered for small destination spaces within the park-like environment. Areas that can be used for yoga studio, small performances, meditation, and relaxation are at the fore-front for this space. A variety of seating areas, spaces of different scales, and a continuous path for a walk or biking are all important elements.

A wide variety of individuals may be entering the park, including researchers, MD Anderson staff, UT students and faculty, MD Anderson family members, and individuals from the surrounding business and community. Embracing this park-like environment will encourage day, evening and weekend activity on campus, reinforcing the narrative of a thriving research campus, a unique contributor to the health and wellness of the MD Anderson and UTHealth community.

Key Attributes

- Dense, tree-lined greenbelt with focus on pedestrian and bicycle friendly approach along Bertner Avenue
- Park-like characteristics that foster contemplation, relaxation and physical health
- Highly planted recreational, athletic, reading and study areas



Places for movement, contemplation, with access to natural light and fresh air, all work together to reinforce the important factors of health, wellness, and mind- and body-connectivity

Connecting the Campus and the Grand Canopy

4. Visualize - Weatherproofing and Outdoor Areas



The campus will be defined by year-round outdoor space that is supported by a vast network of canopies and shade elements that connect buildings and environments into an integrated campus filled with a network of outdoor amenities

Integrated into the master plan approach are environments that respond to issues of climate, access and use. Providing a quality of place that empowers, supports and elevates the individual experience is an important touchpoint of the design. At the heart of the main research quad sits a large social hub space, one that can be considered as a central meeting point, a place with dining areas, coffee bar, and communal gathering for groups and individuals. This large plaza area will be framed by a grand canopy, intended as both an iconic organizational element, as well as functional element, designed to allow researchers and the community to use the space throughout the year. The grand canopy will be directly connected to a second tier of walkway elements that work to both organize and connect the entire campus north to south, and east to west.

Within this network of pathways, canopy elements should be considered for a variety of uses that

maximize pedestrian movement and social gathering even during times of inclement weather, including heat and rain. Canopies that are weatherproof are important aspects of functionality for users moving along pathways between buildings and to parking garages. Both the grand canopy and pedestrian canopy elements will be part of one common architectural language, unifying the campus, and allowing for 24/7 use. (Note: canopy area south of Proton Therapy Center 2 will require removable canopy panels for access to equipment, as well as crane access, to south side of building.)

In addition, other areas should be considered as places where canopies will encourage use and foster an active community among researchers and academics, these may include extension areas where indoor/outdoor building programs exists, defined outdoor rooms, shaded plazas, outdoor spaces between buildings, and activated pedestrian thoroughfares.

Key Attributes

- Iconic grand canopy will serve as large social hub space within the main research quad
- Canopies will directly connect all buildings and provide strong organizational element on campus
- Extensive use of covered and shaded walking paths will ensure that a walkable campus environment can be maintained during rain days and inclement weather



Under Grand, Central Canopy

Campus Arrival Hub

4. Visualize - Arrival Hub



The South Campus arrival hub will be the central drop-off/pick-up point for shuttles, buses, cars, delivery, and bikes. It is imperative that the hub facilitates movement and ease of access. The hub is located along Bertner Avenue and is located within the east-west research quad. The hub will provide the primary central access point for individuals arriving from North and Mid Campus. Shuttle service between the campuses is offered throughout the day and will use this point of connection for South Campus visitors.

The character of the arrival hub will need to facilitate ease of wayfinding and offer canopied/protected waiting areas, amenities, identity graphics, campus map, and will want to employ other key organizational elements to help assist visitors find their way around campus.

The arrival hub should be easily identifiable, easily recognizable, and should announce the campus. The hub could be defined by landscape/hardscape, berms, a visually unifying canopy element, or could employ a variety of other approaches, all working in harmony to offer ease of use, minimize confusion, facilitate traffic, offer ease of navigation for those arriving, and respite for those waiting.

Key Attributes

- Iconic point of connection and arrival point that is easily identifiable, with clarity of wayfinding for vehicular and pedestrian movement
- Defined point-of-entry onto campus that unifies and demarcates this zone as the “campus entry”
- Central point of pick-up/drop-off for vehicles, shuttles, pedestrians, and bicycles arriving from North and Mid Campus
- Vehicular loop to receive and return vehicles onto Old Spanish Trail
- Retractable bollards in Bertner Avenue roadway just south of the Arrival Hub will allow for all vehicles to enter and exit onto Old Spanish Trail, closing off Bertner Avenue at the Arrival Hub to thru-traffic vehicles, to maintain a safe, walking campus environment

Redefining the Central Utility Plan

4. Visualize - Existing Central Utility Plant (CUP)

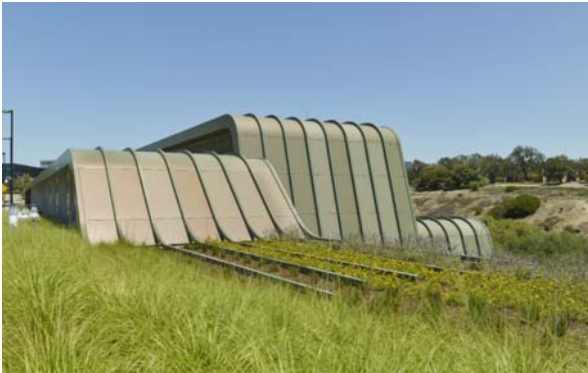

Located within the main east-west axis of the campus, and immediately adjacent to the arrival hub sits an existing Central Utility Plant (CUP) building that will need to be retained in the master plan. Initial studies to relocate the CUP were considered so as to have a clear visual and pedestrian connectivity between SCRB 1 and 2, SCRB 3 and 4, SCRB 5 and the Vivarium. These studies for relocation, however, were cost prohibitive for several reasons. This CUP has significant infrastructure components that serve existing buildings on South Campus and can continue to serve these buildings for 20+ years. This CUP also represents a significant investment by MD Anderson that needs to be leveraged in the overall South Campus master framework.

Given its central location, and close proximity to the main campus arrival point, it is highly recommended that when the existing CUP is decoupled from the adjacent parking garage in the 15-year master plan, that the facility exterior be redesigned and reclad to respond to its prominent location on campus.

The new CUP exterior is considered an opportunity to create a unique visual element that is sculptural, architectural, and reinforces its visual prominence in the quad and arrival areas. A variety of design elements may be employed to help minimize the visual impact of the existing facility. Opportunities to consider may include:

- Articulated façade elements that address scale
- Use of metal screens, metal mesh, translucent glazing
- Use of perforations, color, and light to add dimensionality
- Use of patterning to affect massing, scale, and impact

15 Year Master Framework

4. Visualize - 15 Year Master Framework



Planned growth within the 15-year time frame focuses primarily on the south side of the campus, with the addition of a new West Parking Garage with Central Plant, and a new flexible building pad for MD Anderson in the southwest quadrant of the campus. In the southeast side of the campus, the UTHealth will expand existing facilities along Cambridge Street, and build a new Parking Garage, along with new Research Buildings 1 and 2, with buildings located south of East Road and adjacent to the existing UTHealth School of Dentistry and Behavioral and Biomedical Sciences Buildings.

At the completion of the 15-year construction phase, the SRB Complex (which includes the Smith Research Building, UTHealth Police Department, Physical Plant and Modular Labs) will be demolished and the site prepared for future construction in the 30-year time frame. Once the new parking garage is constructed, the parking garage that is to the north of East Road will be demolished. Parking displaced by the demolition of this old garage will be relocated to the new West Parking Garage. A portion of the old garage building that houses the Central Utility Plant (CUP) will be retained. This CUP, as noted in the 5-Year phase, houses infrastructure components that represent a significant investment by MD Anderson, and that need to be leveraged in the overall South Campus master plan. During the demolition phase of the existing parking structure a portion of East Road will be removed, closing off East Road thru-traffic between Knight Road and Bertner Avenue to routine traffic. An easement will be created where the roadway is removed, and will be designed for use only by emergency service vehicles, providing connection along East Road, with drive access across the easement to the Arrival Hub for exit onto Bertner Avenue. This easement will serve access trucks requiring use of the Water Well Building only.

The UTHealth parking that is displaced by removal of the existing surface parking lot will be accounted for within the new parking structure planned during this phase.

This phase will also include the construction of the Proton Therapy Center 3 (PTC3) building at the corner of Old Spanish Trail and Fannin Street. Patient parking for PTC3 is anticipated to be accommodated on the surface lot adjacent to the building. Staff parking, which is currently accommodated on the PTC3 site, will be relocated to the new West Parking Garage, south of the Vivarium, or off site, accessed via shuttle service.

15 Year Master Framework

4. Visualize - 15 Year Master Framework

Parking Garage Location Option 1 for UTHealth and MD Anderson

MD ANDERSON

	Footprint	GSF
17 West Parking Garage (including Central Utility Plant, Operations Maintenance and Haz Mat.)	60,000 SF	360,000
18 Demo Existing Parking Garage (based on facility condition)	-----	-----
19 Future Needs Building 1 (potential location for UTPD)	55,000 SF	330,000
20 Proton Therapy Center 3	-----	-----
21 Demo Physical Plant, UT Police Department, Smith Research Building, and Modular Labs. Demo Temporary Hazardous Facility.	-----	-----

UT HEALTH

	Footprint	GSF
22 UTHealth Parking Garage + New Central Plant	60,000 SF	360,000
23 Existing Building Expansion	-----	-----
24 Future Needs Building 1	-----	-----
25 Future Needs Building 2	50,000 SF	250,000
26 Reconfiguration of Student Recreation Area	50,000 SF 5.3 Acres	250,000
27 Covered Walkway	-----	-----

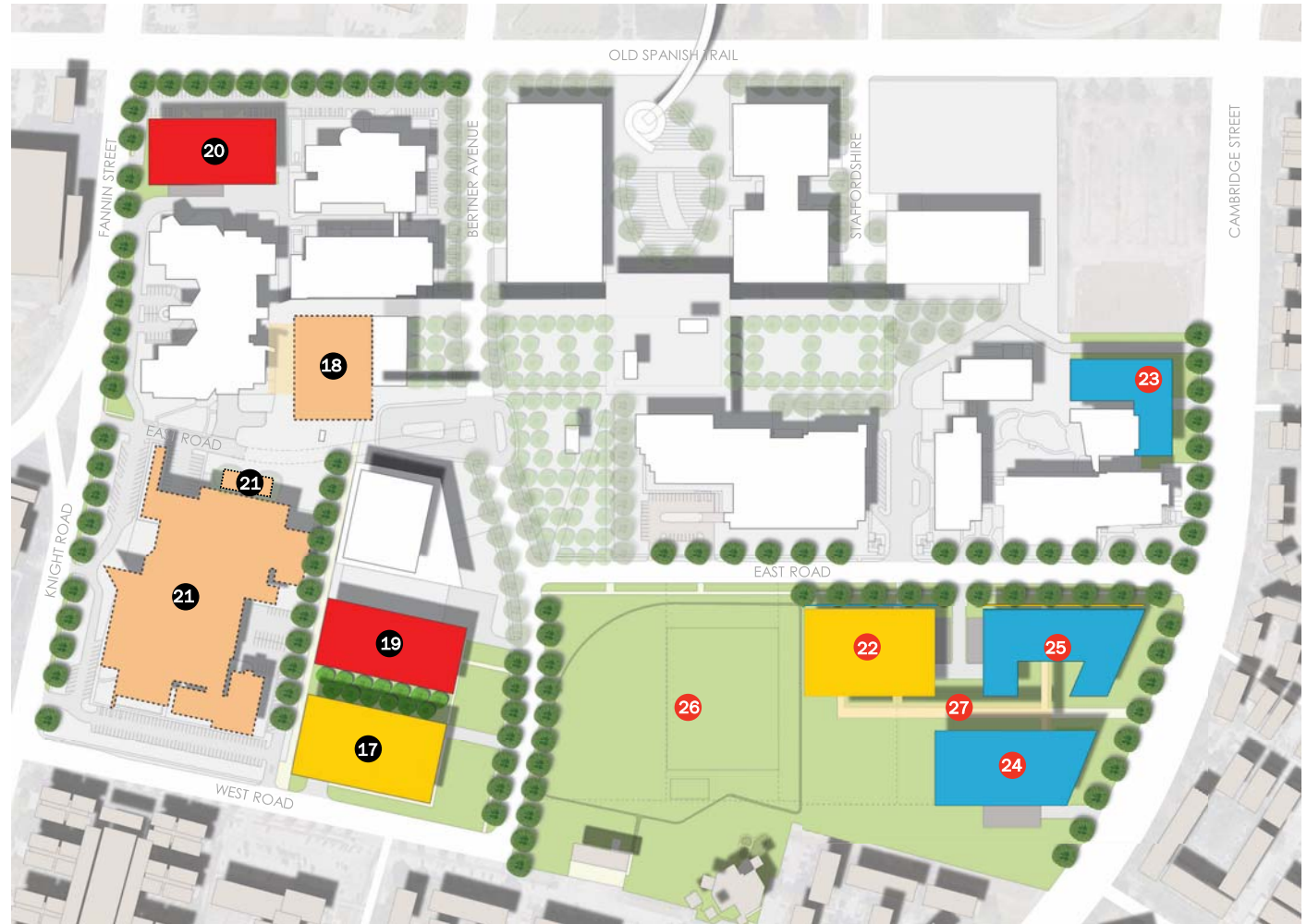

15 Year Master Framework

4. Visualize - 15 Year Master Framework

Parking Garage Location Option 2 for UTHealth and MD Anderson

MD ANDERSON

	Footprint	GSF
17 West Parking Garage (including Central Utility Plant, Operations Maintenance and Haz Mat.)	60,000 SF	360,000
18 Demo Existing Parking Garage (based on facility condition)	-----	-----
19 Future Needs Building 1 (potential location for UTPD)	55,000 SF	330,000
20 Proton Therapy Center 3	-----	-----
21 Demo Physical Plant, UT Police Department, Smith Research Building, and Modular Labs. Demo Temporary Hazardous Facility.	-----	-----

UT HEALTH

	Footprint	GSF
22 UTHealth Parking Garage + New Central Plant	60,000 SF	360,000
23 Existing Building Expansion	-----	-----
24 Future Needs Building 1	-----	-----
25 Future Needs Building 2	50,000 SF	250,000
26 Reconfiguration of Student Recreation Area	50,000 SF 5.3 Acres	250,000
27 Covered Walkway	-----	-----

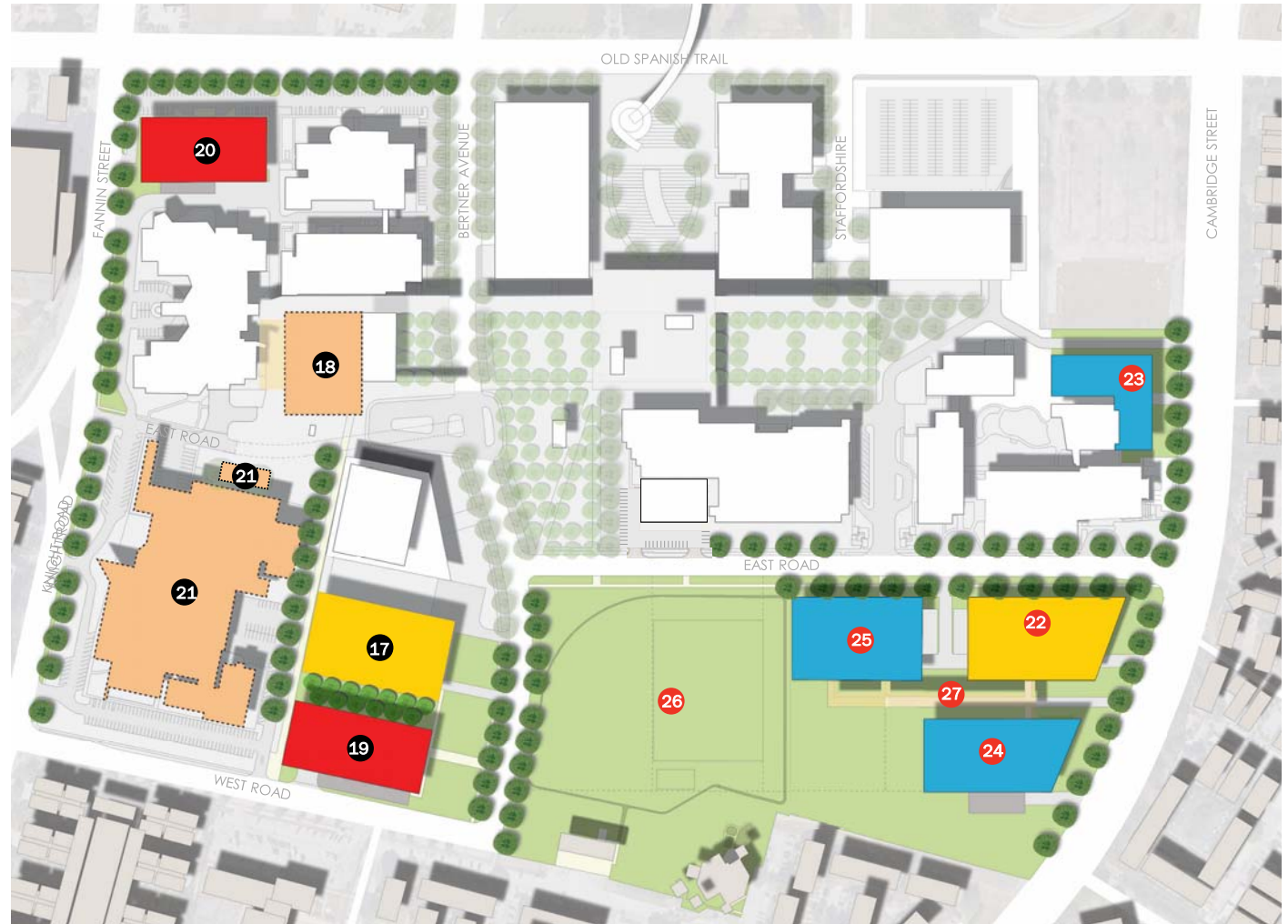

15 Year Phasing Components

4. Visualize - 15 Year Phasing Components

1. West Parking Garage, Central Utility Plant, Hazardous Storage and Operations and Maintenance Facility

- Build new West Parking Garage (including Central Utility Plant facility, Hazardous Waste Facility and Operations and Maintenance facility at corner of West Road and Bertner.
- Primary parking garage entrance / exit will be located off West Road, with a secondary entrance and exit from Bertner Avenue.
- New Central Utility Plant, Hazardous Waste Facility and Operations and Maintenance facility will be located on the first level with shared loading zone and service vehicle parking.
- Limitation of this option is the increased walking distance from the garage to buildings to the north, including SCRB 1 and 2, along with potential staff parking for Proton Therapy Center 1, 2 and 3 (refer to Parking Study section, last slide, for walking distances)
- An alternate option for the parking garage has also been provided off Bertner
 - Provides access/exit from Bertner only. Given the size anticipated for this garage, a single source entry/exit may not be feasible.
 - In this option the garage is located closer to the buildings to the north but does isolate Future Needs Building 1 from the rest of the campus. This may not be an issue in the 30 year plan or if the other Future Needs Buildings are built along with Future Needs Building 1.
- Provide covered walkways from garage to adjacent buildings for ease of access during inclement weather
- Concurrent with the building of West Parking Garage, install roadway bollards along Bertner Avenue and south of Arrival Hub for traffic control to allow for closure of Bertner Avenue at circular drive of Arrival Hub - Bollards at roadway will allow for closure to thru-traffic along Bertner Avenue, restricting vehicular commuting traffic through campus, increasing pedestrian safety and fostering a walking campus environment
- Consider upgrades to east facade of SCRB 1 and 2 to appropriately engage the adjacent quad area, specifically to shield dock area from view

2. Building Demolition - Parking Garage

- Demolish existing parking garage located along East Road when West Parking Garage is complete and online. Decision to demolish the garage to be made based on condition of the facility and the parking demand on site.
- Decouple and retain existing Central Utility Plant from existing parking garage
- Provide new exterior upgrades and new exterior enclosure to areas of existing Central Utility Plant building affected by decoupling from garage.
- Provide new landscape and hardscape design at area of parking garage removal

3. Water Well Building

- Reclad and provide exterior upgrades to existing Water Well Building, providing new, enhanced exterior enclosure
- Integrate well into Research Quad with upgraded design and landscape features, while retaining ease of emergency vehicle access

4. East Road

- Extend closure of East Road with termination of roadway at service dock area to SCRB 1 and 2
- Provide easement at area of road closure between SCRB 1 and 2 and Arrival Hub
- Area of easement to be designed as a contiguous part of the greenbelt that connects the east-west Research Quad with the Vivarium and Arrival Hub
- Area of easement to utilize hardscape and landscape features to blend into the surroundings, while providing access for emergency service vehicles to drive from East Road through the easement area to access the Water Well Building and Bertner Avenue

5. Future Needs Building 1

- Build new Future Needs Building 1 located south of the vivarium (option 1 and corner of Bertner and West road as Option 2)
- Primary building entrances to be along Bertner Avenue, as well as along west side of building where future quad is planned
- Main service entrance and dock area for Building 1 to be located with access to Bertner (option 1 and from West Road in Option 2)

6. Proton Therapy Center 3

- Provide for displaced detention pond on current Proton Therapy Center 3 site
- Incorporate detention pond physical requirements (which were built as part of Proton Therapy Center 2) into civil considerations for design of Proton Therapy Center 3
- Build new Proton Therapy Center 3 building located at the corner of Old Spanish Trail and Fannin Street
- Primary building entrance to be provided along north side of building off Old Spanish Trail (access from Fannin Street could also be considered as main access for building entry)
- Secondary building entrance to be provided along east side of building, providing connectivity to Proton Therapy Center 2
- Main service entrance and dock area for Proton Therapy Center 3 to be located along south side of building and shared with SCRB 1 and 2 dock/receiving area access road
- Provide new visitor parking that connects Proton Therapy Center 3 lot with Proton Therapy Center 2 lot

15 Year Phasing Components

4. Visualize - 15 Year Phasing Components

7. Relocation of UT Police Department

- University of Texas Police Department housed in the Smith Research Building to be relocated in advance of the demolition of existing building
- University of Texas Police Department will be relocated to a location within South Campus or Mid Campus (Mid Campus may provide a better location as it would provide equal distance / travel time to North and South Campuses)
- Options for location under consideration are
 1. Future Needs Building 1 on South Campus with some offices in 1MC
 2. St. Agnes Site on Mid Campus with some offices in 1MC
- These options are considered as short-term options that allow the decompression of the existing UTPD space by relocating some office functions to 1MC.
- Long term, the relocation of offices to 1MC will include consolidation of these same offices on either of the two sites noted, with the rest of the department.

8. Building Demolition - Physical Plant, UT Police Department, Smith Research Building, and Modular Labs (SRB Complex)

- Demolish SRB Complex along with adjacent parking, landscape and hardscape features when functions such as research and UTPD from previous phases come online
- Rough grade and prepare for new construction in future phases
- The demolition of SRB Complex may be considered in an earlier timeline than in the 15-year timeframe. Given building condition and expenditures needed for maintenance, the demolition of SRB Complex could be considered on its own timeline after the construction of SCRB5. Consideration must be given to O&M facility and UTPD Facility locations.

9. UTHealth Parking Garage and Reconfiguration of Recreation Area

- UTHealth to build new parking garage located along East Road to the south of SCRB 3 and 4
- An important consideration for phasing of the garage is to build it prior to building any other buildings on the site, to allow UTHealth to retain access to a majority of the existing surface parking lot along Cambridge Street while new parking structure is under construction
- Upon completion of the garage, surface parking can be displaced to this garage to allow for construction of research buildings
- Upon completion of parking garage, UTHealth to rework greenspace, particularly the outdoor running track area to adjust the track loop to accommodate new parking garage
- An alternate location for the garage is to place it adjacent to Cambridge Street
 - Pros for this option are that there can then be two entrances /exits for a parking garage this size – off East Road and off Cambridge Street, which is a better parking solution than the internal campus location
 - Traffic can be maintained at the periphery of the campus versus being directed internally to the campus
 - The cons to this alternate location are the walking distances to Research Building 3 as well as the displacement of surface parking before new parking garage can be constructed
- Both parking locations will require enhanced safety and security measures for pedestrians crossing East Road (refer to Parking and Traffic Studies for further clarification)

10. UTHealth Existing Building Expansion

- UTHealth to construct addition to existing conference center located along Cambridge Street
- Building addition will affect existing detention pond located on site (refer to Civil Analysis section for relocation of detention area)
- Primary entrance for this building to be located off Cambridge Street

11. UTHealth Future Buildings 1 and 2

- UTHealth to construct new Future Needs Buildings 1 and 2
- Primary building entrance for Future Building 1 to be provided along north side of building, as well as along west side of building providing connectivity to outdoor areas and other research buildings
- Main service entrance and dock area for Future Building 1 to be located along south side of building, with service vehicle access along Cambridge Street
- Primary building entrance for Future Building 2 to be provided along north side of building facing SCRB 3 and 4, as well as along south side of the building providing connectivity to recreational green space and adjacent research building
- Main service entrance and dock area for Future Building 2 to be located along east side of the building adjacent to the new parking garage
- Construct new covered walkway connecting the Parking Garage, Future Buildings 1 and 2, using an architectural approach similar to other canopy elements on campus, creating a common vernacular across the site



15-year plan, 3D View



15-year alternate plan, 3D View

30 Year Master Framework

4. Visualize - 30 Year Master Framework



The 30-year plan realizes the complete build-out of the South Campus site and includes completion of all building and infrastructure construction for both MD Anderson and the UTHealth, as well as the complete development of outdoor quads, pedestrian and walking paths, social and event spaces, recreation areas and student gathering spaces.

In the southwest quadrant of the site Future Needs Buildings 2 and 3 are provided for flexible, future-state programs, along with a new north-south research quad, both located where the Smith Research Building Complex previously resided.

The completion of construction in the northeast quadrant of the site will include a new MD Anderson Future Needs Building 4 at the intersection of Old Spanish Trail and Staffordshire Road.

In the southeast quadrant of the site, UTHealth will construct UT Future Needs Building 3 along East Road. The central park and recreational quads located adjacent to this area will be developed to include new amenities that are unique to the south side of the campus and that also serve the student housing and residential community to the south of the campus site.

30 Year Master Framework

4. Visualize - 30 Year Master Framework

MD ANDERSON

	Footprint	GSF
28 Future Needs Building 2	90,000 SF	540,000
29 Future Needs Building 3	60,000 SF	360,000
30 Future Needs Building 4	45,000 SF	225,000
31 Shared Resources	10,000 SF	360,000
32 Research Quad	5.0 Acres	-----
33 Central Park Expansion	2.9 Acres	-----
34 Covered Walkway	-----	-----

UT HEALTH

	Footprint	GSF
35 Future Needs Building 3	50,000 SF	250,000
36 Recreational Quad	4.3 Acres	-----
37 Covered Walkway	-----	-----

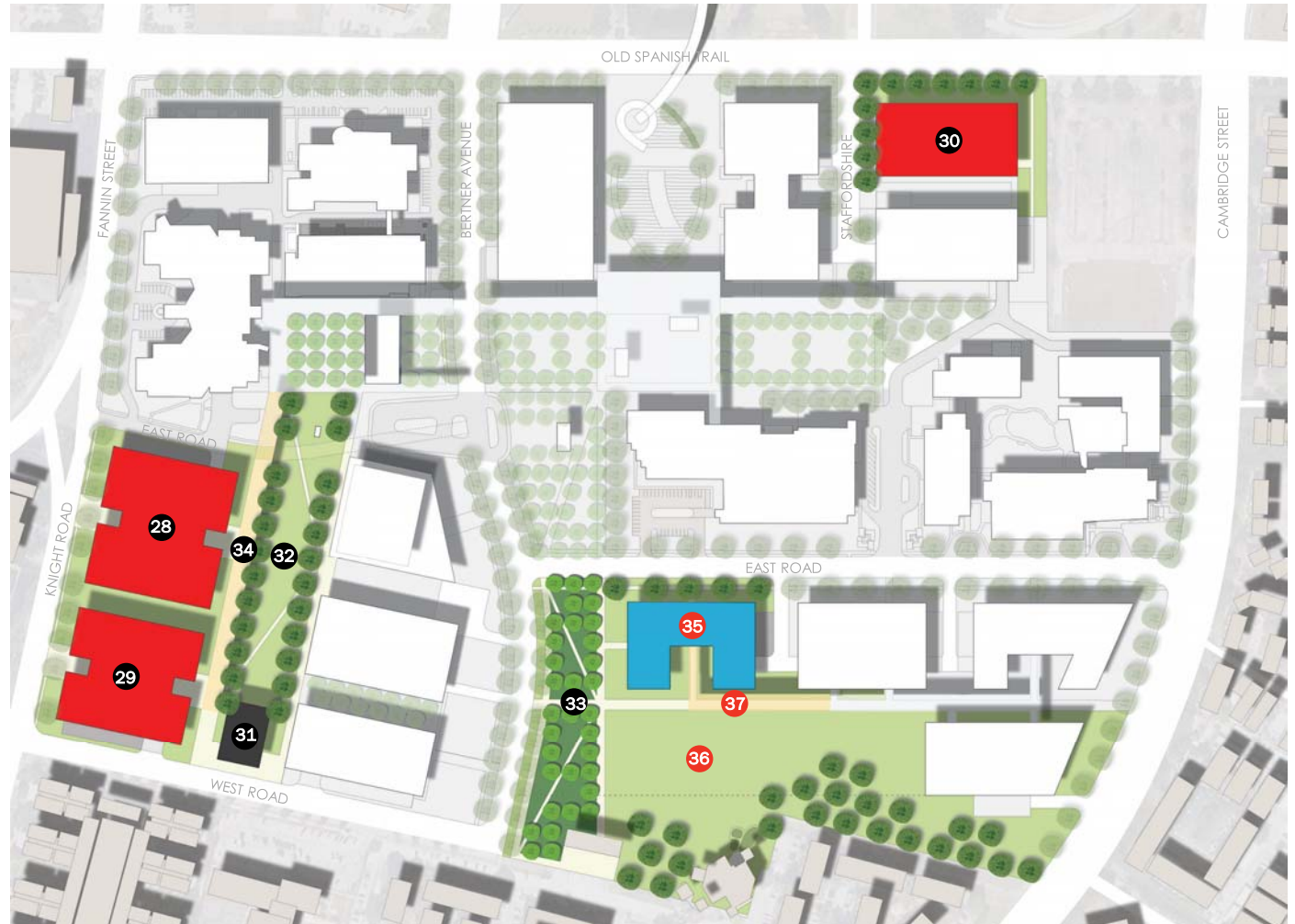

30 Year Phasing Components

4. Visualize - 30 Year Phasing Components

1. Future Needs Buildings 2 and 3

- Build new Future Needs Buildings 2 and 3 (for future programs) located along Knight Road
- Primary building entrances for both Future Needs Buildings 2 and 3 to be provided along east side facing new planned Research Quad
- Primary building entrances also to be provided along Knight Road
- Main service entrance and dock area for Future Needs Building 2 to be located on north side of the building for access from East Road and adjacent to service zone for SCRB 1 and 2
- Main service entrance and dock area for Future needs Building 3 to be located on south side of building for access from West Road

2. Research Quad and Shared Resources

- Construct new Research Quad providing north- south connectivity between new Future Needs Buildings 2 and 3, SCRB 1 and 2, Proton Therapy Center 2, and East-West Main Quad to the north
- Research Quad will provide primary pedestrian connectivity between Future Needs Buildings 1, 2, and 3, Vivarium and new West Parking Garage creating a central shared space for the users on the south side of the campus
- Construct covered walkways that connect Future Needs Buildings 2 and 3 with covered walkway components constructed in first and second phase, thus connecting all the buildings via pedestrian walkways
- Covered walkways to use architectural approach similar to other canopy elements on campus, creating a common vernacular amongst shaded elements
- Construct new Shared Resources Building at south side of new Research Quad. This facility could house food, conference, exercise, and any other shared resources facility for MD Anderson and UTHealth.

3. Future Needs Building 4

- Construct Future Needs Building 4 located along Old Spanish Trail
- Primary building entrances to be provided along Old Spanish Trail on the north, as well as on the west side of the building facing Staffordshire
- Main service entrance and dock area for the building to be located on west side of building for access from Staffordshire

4. Central Park Expansion

- Construct remaining portion of Central Park south of East Road and extending to the south property line
- Newly completed Central Park to provide continuous park experience from north to south, providing campus access as well as shared access for University of Texas student housing located adjacent to the south property line
- Landscape and hardscape vernacular to match that of the Central Park zone to the north to provide one continuous design vocabulary north to south, within the overall Central Park zone
- New Central Park to provide shaded, tree lined greenbelt along Bertner Avenue with park-like amenities that connect from north-to south across the site and provide a continuous pathway from the Main Piazza and Grand Entry to the southernmost edge of the side
- The Central Park amenities will reside primarily along the east side of Bertner Avenue, however, the large tree-lined pathway that occurs along the roadway will also extend along the west side of Bertner Road, to create a dense, tree-lined canopy through the central heart of campus where bikes and pedestrians may pass through from the south residential side of campus through to the north side of campus

5. UTHealth Future Building 3

- UTHealth to construct new Future Needs Building 3. This building could be an MD Anderson building versus a UTHealth building, depending on how the campus is developed between the two sister institutions in the future.
- Primary building entrances to be provided along north side of building facing existing UTHealth campus off East Road, as well as along south side of building providing connectivity to outdoor areas and other buildings
- Main service entrance and dock area for Future Building 3 to be located along east side of building off new connector road for access to East Road. This new connector road will also provide access to the parking garage

- Construct covered walkway extension element providing common connection between Parking Garage, Future Buildings 1, 2 and 3

6. Recreational Quad

- Construct new Recreational Quad providing connectivity at south side of the site as well as connectivity to UT Future Buildings 1, 2 and 3
- Recreational quad to provide amenities that foster use by the adjacent UTHealth housing community which may include outdoor athletics such as running track, strength training stations, tennis courts, as well as other social, study, and athletic functions



30 Year Plan, 3D View



NORTH CAMPUS

TMC³ CAMPUS

SOUTH CAMPUS

30 Year Plan, 3D View

Loading Dock and Service Access

4. Visualize - Loading Dock and Service Access

Dock and Service Access Approach

- Approach to access for new buildings includes dock and truck delivery service at each building
- Dumpsters and service areas should be concealed to protect pedestrian nature of campus aesthetics

5 Year Master Framework

- New buildings (SCRB 5, Vivarium, MD Anderson Education Building, and UTHealth Education Building) provided with own dock and small truck and delivery vehicle service access
- Dock for SCRB 5 and MD Anderson Education Building to be located one level below grade
- Dock access for SCRB 5 to occur from Bertner Avenue
- Dock access for MD Anderson Education Building and UTHealth Education Building to each occur from Staffordshire
- Main service entrance to Vivarium to be provided from Bertner Avenue, and includes a full-service dock, vet med service / small vehicle delivery / drop-off zone, as well as service vehicle parking zone for 10-12 vehicles
- Alternate Layout: Dock at new Vivarium Building to provide shared dock access with future West Parking Garage (West Parking will include Central Plant facility, Hazardous Storage Facility and Operations and Maintenance facility)
- Service access for East Parking Garage to occur from Staffordshire
- CenterPoint service vehicle access required at the East Parking Garage for normal / emergency power switchgear equipment
- Dumpsters and service areas should be concealed to protect pedestrian nature of campus aesthetics

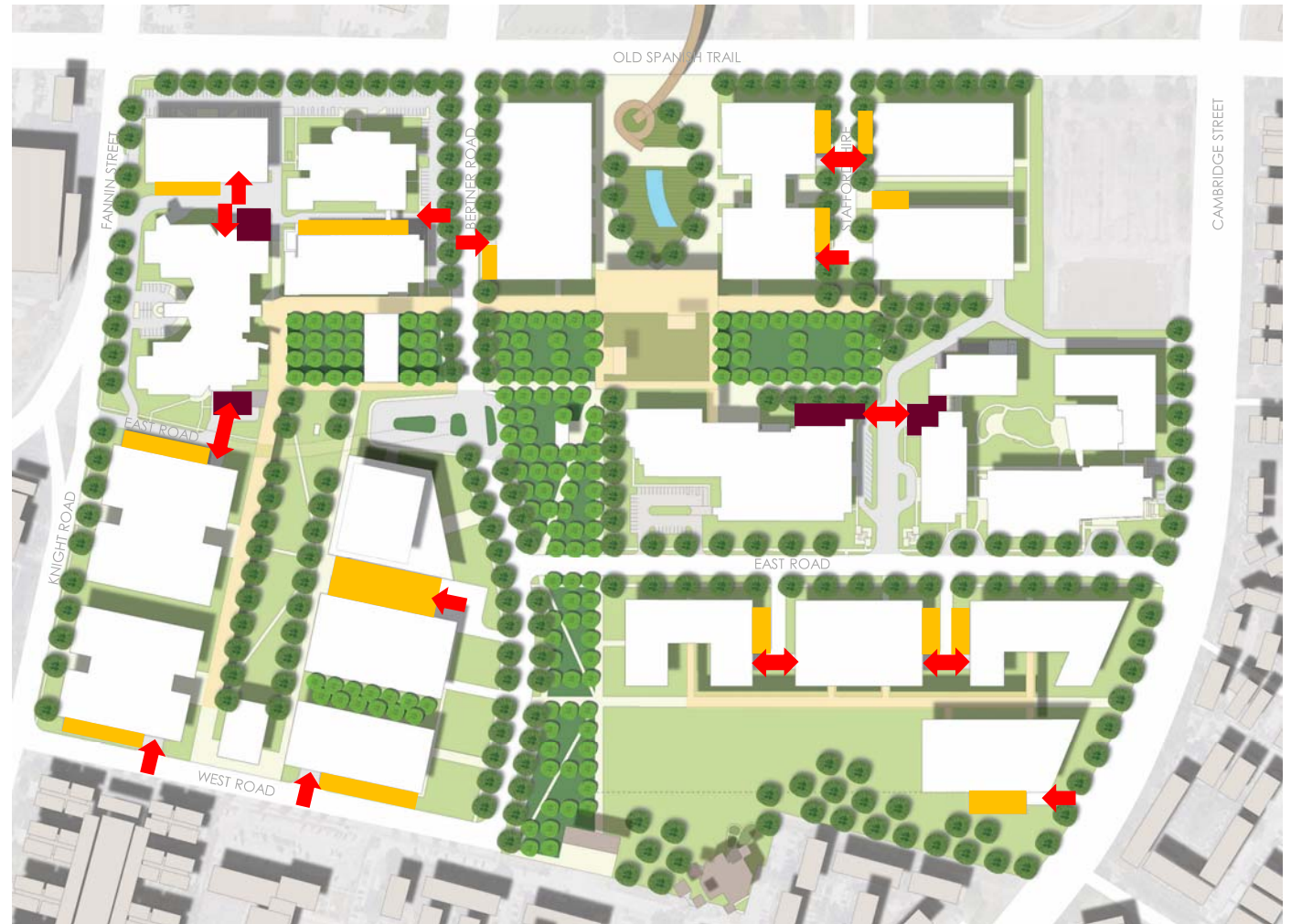

Research Quad

4. Visualize - 30 Year Plan, Outdoor Environments and Open Areas



This 5-acre research quad located in the southwest quadrant of the campus provides an opportunity to create outdoor gathering space designed for researchers and academics. With three new research (flexible program) buildings flanking the quad, as well as the Vivarium, SCRB 1 and 2, and new amenity building to the south, the quad is intended to include shaded outdoor meeting spaces, individual outdoor work and lunch areas, along with other types of touch-down and amenity spaces. New buildings will include active ground floors programmed with amenities such as retail, meeting space, gym facilities, and other amenities that open to the quad and promote indoor-outdoor use and connectivity.

The quad will be book ended at the north side with the Conferencing Center located within SCRB 1, and a shared resource building flanking the south end of the quad that could be considered for library, conferencing, or other uses

A covered walkway will connect the new Shared Resources Building and Future Needs Buildings 2 and 3 with SCRB 1 and 2, and the Main East-West Research Quad, providing ample shade and weather protection for staff crossing the campus.

Key Attributes

- Shaded areas to meet and convene as work groups
- Indoor-outdoor connectivity to adjacent buildings
- Pre- and post-function space adjacent to conferencing centers at north and south side of quad
- Outdoor touch-down space, individual and small groups meeting spaces, and ample shaded lunch areas



Creating a vital, vibrant community includes providing outdoor space that serves a variety of interests, such as individual, contemplative, communal gathering, and outdoor meeting space

Central Park Extension

4. Visualize - 30 Year Plan, Outdoor Environments and Open Areas



Located to the south of East Road, the Central Park Extension represents the full realization of the Central Park in its entirety, completing development of the park from the 5-year plan.

The completion of the park links the campus, in its entirety, north to south across the site. This south extension will sit immediately adjacent to the UTHHealth recreational quad and will serve a wide variety of users including students and families.

The character and environment of the central park is special, unique, highly planted, recreational and contemplative. The space, landscape and destination is intended to feel distinctly different from other open areas on campus.

Extending from Old Spanish Trail down to West Road, the park is a place for outdoor meditation, yoga, a place to have lunch, read a book, stroll with friends and family, as well a place to pass through on a bike, a space to renew, refresh and replenish.

Consideration should be given to the experience that happens along Bertner Road, and the rich contribution that the central park will provide to this main artery through the campus. Central Park will include a shaded, tree lined greenbelt along Bertner Avenue. While the Central Park amenities will reside

primarily along the east side of Bertner Avenue, the large tree-lined pathway that occurs along the roadway will also extend along the west side of Bertner Avenue, creating a dense, tree-lined canopy north to south, and through the campus, where bikes and pedestrians may pass through campus. Creating an environment that will contribute to the reduction of traffic and speeds along Bertner Avenue will be important to this walking campus.

A wide variety of individuals may be entering the park for access to the adjacent recreational facility embedded in this community. Special consideration for these users should be included when planning the south portion of the park. Encouraging a diverse population of students and families south of the site to engage in the outdoor environments will work to reinforce a thriving community that includes evening and weekend users from the local neighborhoods.

At the completion of the Central Park Extension, there will be a continuity of design between the original central park construction and the new extension, with both areas reading together with a comprehensive, cohesive plant and material palette, design approach, as well as a cohesive family of environmental furnishings, environmental lighting, street design, as well as a complimentary approach to street trees and walkways.

Key Attributes

- Dense, tree-lined greenbelt with focus on pedestrian and bicycle friendly approach along Bertner Avenue
- Strong connectivity and program space for adjacent UTHHealth student housing community
- Seamless integration with adjacent recreational quad, embracing opportunities for recreational athletics, family and student use

Embracing a park-like environment in the heart of campus reinforces the narrative of a thriving research and academic community, a unique contributor to health and wellness for all

Recreational Quad

4. Visualize - 30 Year Plan, Outdoor Environments and Open Areas



Providing opportunities for recreation and play, the Recreational Quad offers a unique opportunity to build health and wellness within the academic campus environment.

Located immediately adjacent to the UTHealth student housing along the southern edge of the campus, this quad is intended as a link to the local community, as well as a place for respite and exercise for students, researchers and staff. The space offers a unique opportunity for the community, MD Anderson

and the UTHealth, to blend seamlessly on the site, promote family engagement, and offer opportunity for families, neighbors, and locals. This recreational space can be used for jogging, biking, strength training, tennis, as well as a variety of other outdoor sports activities. The space also offers a special opportunity for researchers to take a break during work for exercise, health, and wellness. The quad functions also promote evening and weekend use, contributing to a thriving, diverse community campus.



Spaces for recreational athletics, within the park-like campus will foster community engagement, evening, and weekend use, and continue narrative of a thriving, diverse campus environment

Appendix H
South Campus Master Framework

Civil Analysis



City of Houston Public Infrastructure

2. Analyze – Existing Conditions

The City of Houston's Geographic Information Mapping System (GIMS) documents existing public infrastructure. By analyzing the existing public infrastructure nearby, will help us determine if there is adequate and available public utilities to serve the proposed development as well as identify public utility connection points. There is also water and sanitary lines dedicated to the City within easements as part of past infrastructure improvements . The following is a summary of existing public utilities in the area:

Sanitary Sewer Main

12-15" pipes along the north site boundary on Old Spanish Trail

72" pipes along the east site boundary on Cambridge St

10-18" pipes along the west site boundary on Fannin St/Knight Rd

Water Main

12" pipes along Bertner Rd

12" pipes along East Rd

12" pipes along West Rd

Pipes of various sizes along north, east, and west site boundaries

Storm Sewer Main

24" pipes along the north site boundary on Old Spanish Trail

30-42" pipes along the east site boundary on Cambridge St

30-102" pipes along the west site boundary on Fannin St/Knight Rd

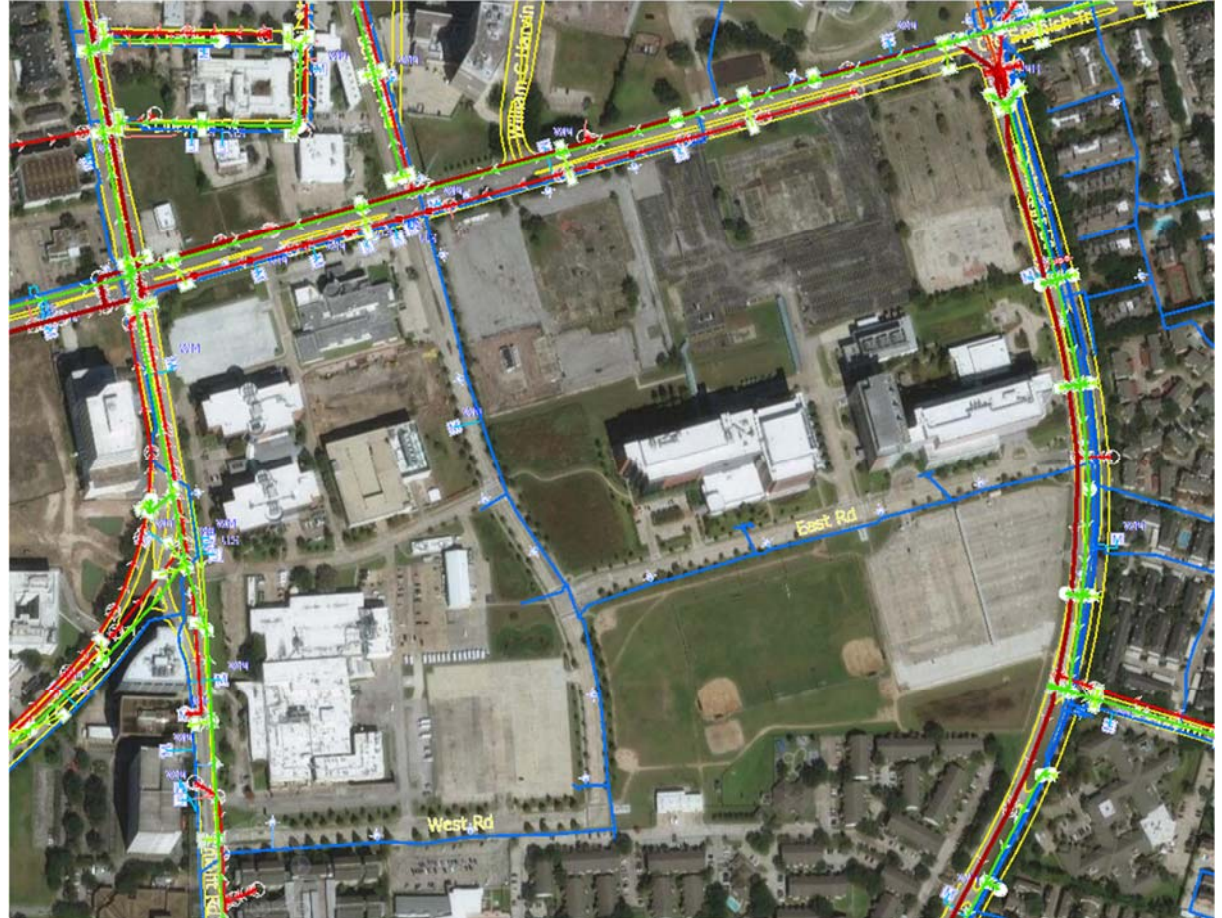

Figure 1. City of Houston GIMS Map

South Campus Infrastructure

2. Analyze – Existing Conditions

Existing utility information has been obtained from receipt of record drawings. However, information from these drawings cannot be verified for accuracy until an updated survey for the project site is provided. Field verification of all utilities is recommended prior to any work being completed on site.

All public utility connections will need to be coordinated with the City of Houston Public Works. All utilities shall be finalized in the construction documents and shall be coordinated and designed to meet or exceed local code requirements.

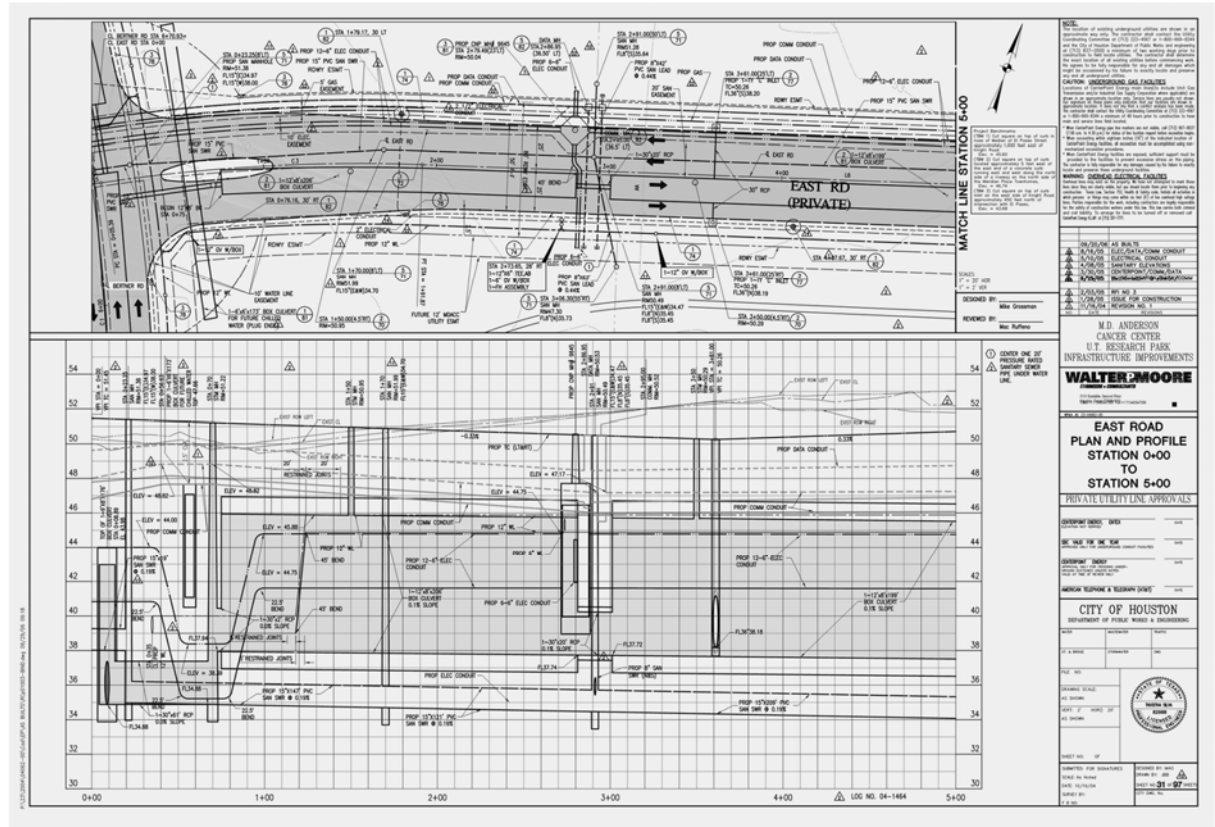

Figure 2. Campus Infrastructure Record Drawings

Floodplain

The existing MD Anderson South Campus site is mostly paved and hosts multiple buildings for research, parking as well as staff operations and maintenance.

The proposed master plan will be comprised of many updates including a central utility plant in the 15 year time frame and research facilities containing several loading bays, offices, and storage rooms. Many of the proposed hospital facilities can be considered critical facilities that materially affect the public health and welfare.

The Federal Emergency Management Agency (FEMA) Flood Insurance Rate Maps (FIRM) provides flood hazard and risk data to help guide mitigation actions. The FEMA flood maps delineate the floodplain limits and flood hazard zones for the campus. The current FEMA Flood Insurance Rate Map panel for this area is 48201C0860L revised June 18, 2007. Per this FIRM map, the receiving channel for the MD Anderson South Campus Cancer Center is the Brays Bayou.

There are proposed structures that are considered critical facilities and are partially located within the 500-year floodplain (0.2 percent or greater chance of flooding). For critical facilities located in an area that is subject to a 500-year of flooding in any given year (X Shaded Zone), all additions, new construction, and substantial improvements shall have the lowest floor elevated or flood proofed to at least three feet above the elevation that is subject to a 0.20 percent or greater chance of flooding. Additionally, any site improvement within the effective floodplain to demonstrate zero net fill below the effective flood elevation.

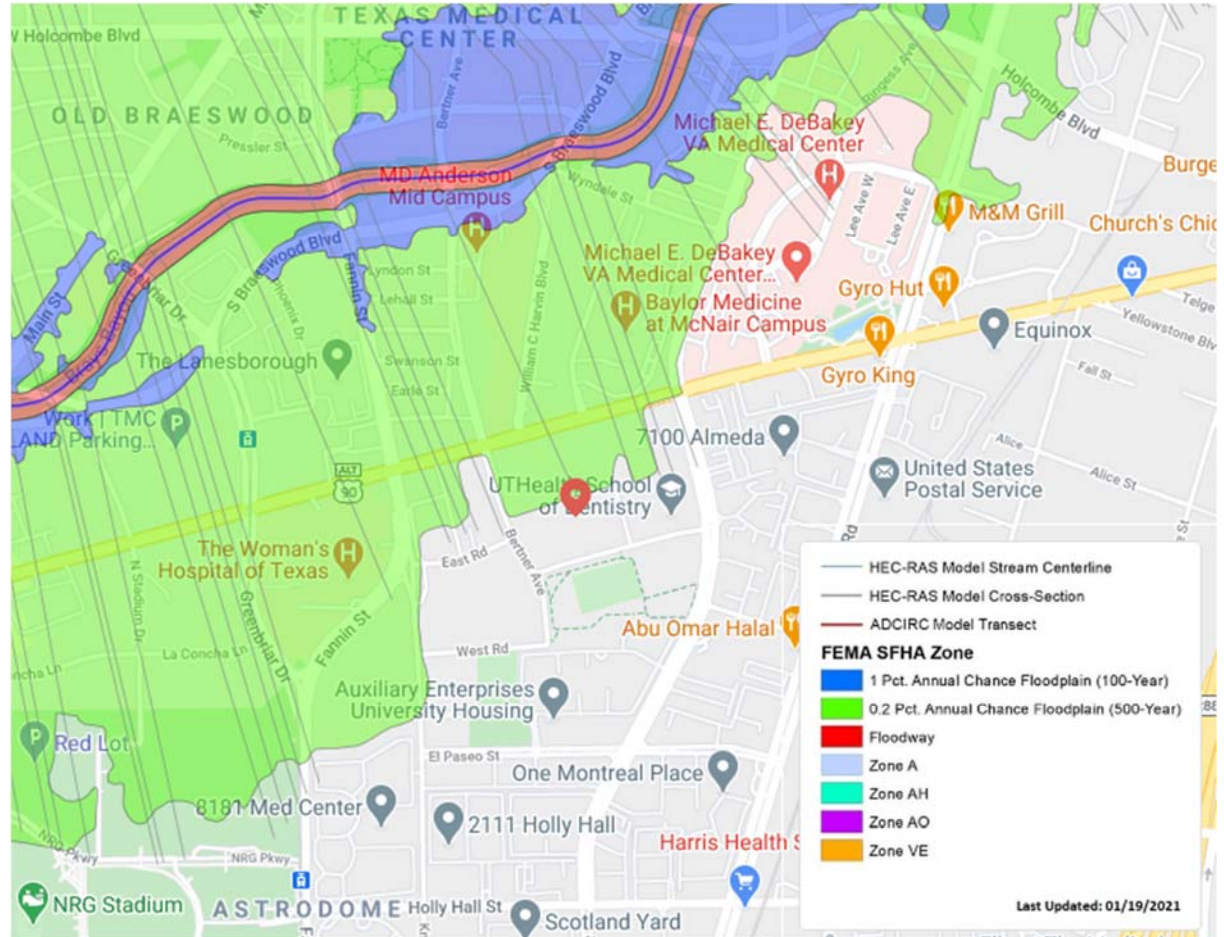

Figure 3. Floodplain Map

Key Findings

Through review of existing public infrastructure surrounding the site and record drawings of the campus the following is a summary of our findings.

There is available storm, sanitary, and water lines of various sizes throughout the campus. The proposed buildings can be served by the internal and surrounding existing utilities infrastructure. No additional infrastructure will need to be brought to the proposed site from an off-site location.

On-site sewage treatment plant will not be required, and the existing on-site sewage system can handle the proposed effluent from the proposed buildings.

There are existing underground detention system located throughout the site that can be partially utilized for the future improvements.

There are underground detention box culverts placed underneath Bertner Ave and East Rd.

Storm Troopers for Storm Water Quality are located at the end of Bertner Ave off Old Spanish Trail, at the end of East Rd off Cambridge Street, and at the end of West Road off Knight Road

Franchise utilities such as telephone, power, gas, and cable are located on site and any additional infrastructure will not need to be brought to the proposed site from an off-site location or as part of proposed infrastructure improvements.

The design code for civil engineering scope items will be based upon guidelines set forth by the City of Houston and other applicable jurisdictions. Refer to Architect and other disciplines for relevant building code information.

The proposed buildings will meet all Fire Code requirements of the local jurisdiction.

Private roads, drives, and fire lanes will be reviewed and designed to City of Houston standards as site development improvements.

All site paving must be in accordance with any Owner guidelines, City of Houston, and the Americans with Disabilities Act (ADA) requirements. The design will comply with the most stringent of the aforementioned documents.

City of Houston requirements for storm water detention, pollution prevention, and quality will need to be adhered to.

While the information furnished herein is from reliable sources, the information is subject to change without notice and is subject to the following, all of which could produce substantially different results: changes in assumptions about future circumstances, events outside our control, differences in City (City of Houston – COH) and County (Harris County) criteria, and changes of price, rental and other conditions. The City of Houston periodically reviews and revises their infrastructure criteria. It is expected the revised criteria to be implemented in the future, after which the new criteria will be applicable to all new development.

5 Year Plan

4. Visualize - Proposed Future State

LEGEND

TYPE	SYMBOL
Prop Storm Sewer	
Prop Detention System	
Prop Water	
Prop Sanitary Sewer	
Alternate Storm Option	
Detention Service Area	

NOTES

NO.	NOTES
1	Connect to existing Old Spanish Trail road storm system to serve new buildings and site improvements (SCR5, MD Anderson Education Building, Uthealth Education Building, Parking Garage, Pizza, Main Quad, etc.)
2	Maximize underground detention within parking garage and hardscape areas. Approximate drainage area shown is outside of existing detention service area Alternate storm connection to existing Cambridge Street storm system
3	Connect to existing water mains on Old Spanish Road and Bertner Avenue to create water loop. Provide two water service points of connections for each building where required
4	Connect to existing sanitary mains on Old Spanish Trail and Bertner Avenue
5	Connect to existing water and sanitary sewer stub outs.
6	Connect to existing storm sewer on Bertner Avenue. Utilize detention credits and/ or provide detention delta to meet detention required.

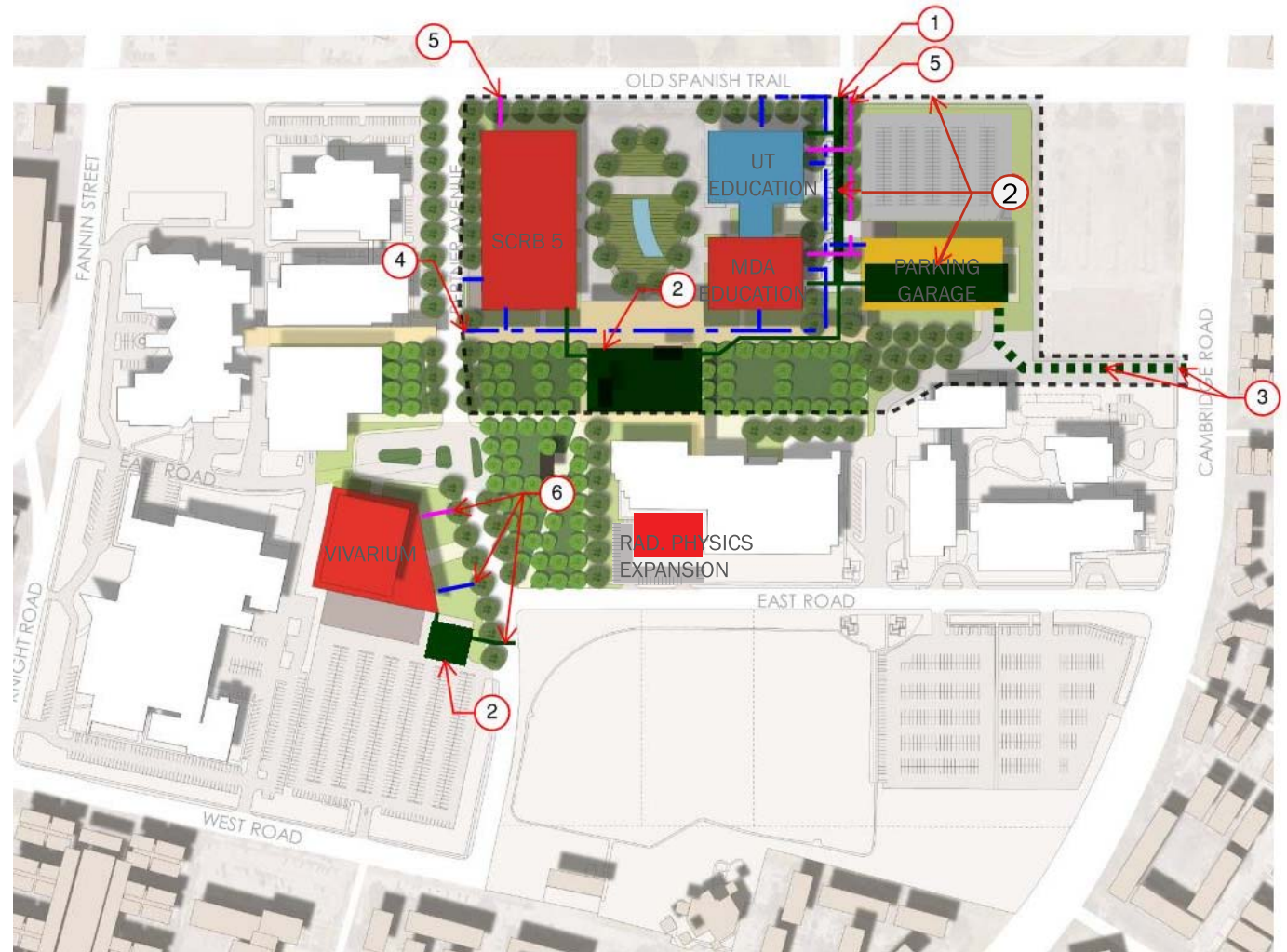

15 Year Plan

LEGEND

TYPE	SYMBOL
Prop Storm Sewer	
Prop Detention System	
Prop Water	
Prop Sanitary Sewer	
Alternate Storm Option	
Existing Water	

NOTES

NO.	NOTES
1	Connect to underground detention within parking garage and hardscape areas.
2	Connect to existing East Road water main and water loop for water connection to each building
3	Connect to water and/ or sanitary mains on Bertner Avenue, East Road or Cambridge Street

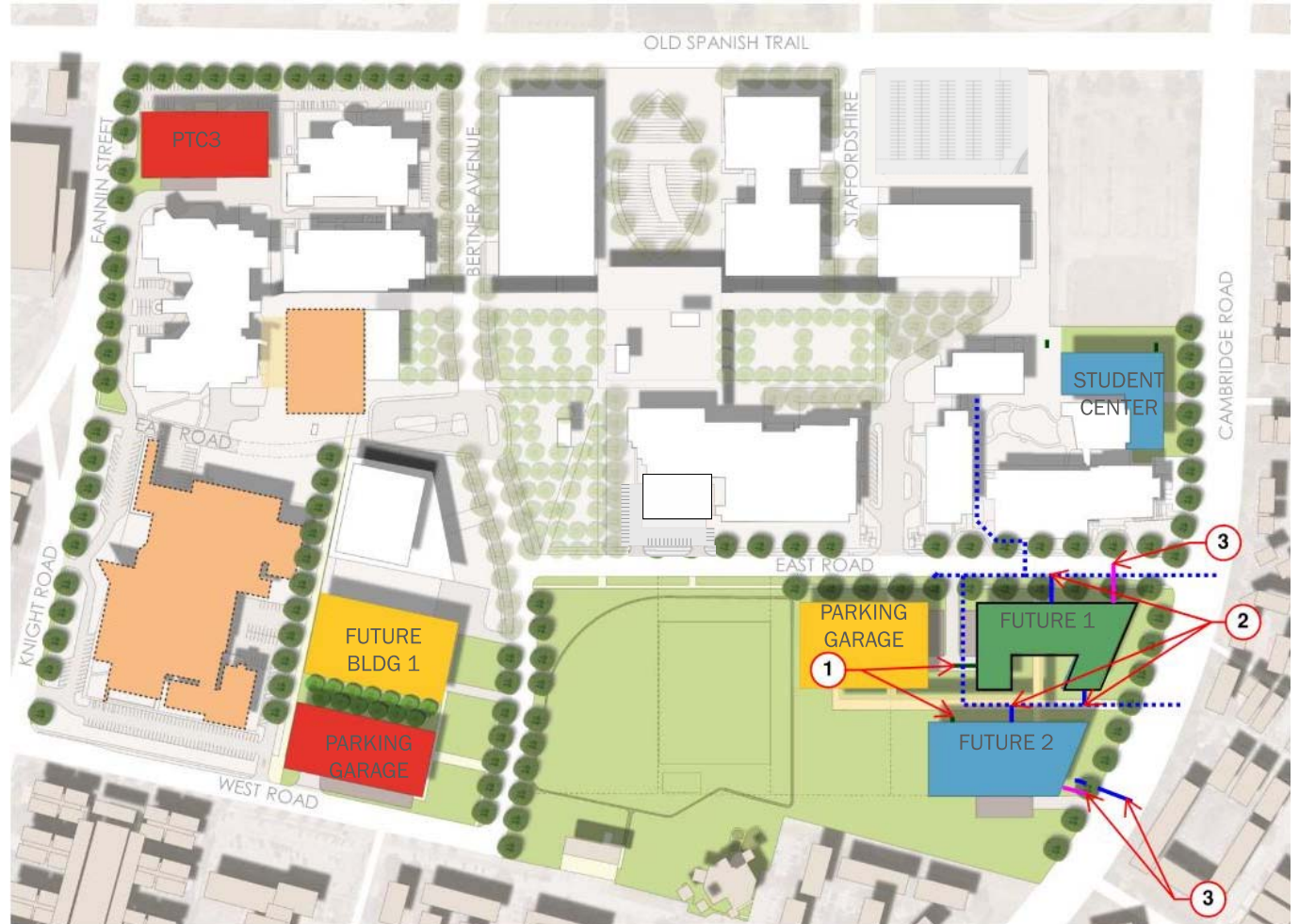

30 Year Plan

LEGEND

TYPE	SYMBOL
Prop Storm Sewer	
Prop Detention System	
Prop Water	
Prop Sanitary Sewer	
Alternate Storm Option	
Existing Water	

NOTES

NO.	NOTES
1	Connect to existing storm, sanitary, and water mains on Knight Road, West Road and/ or East Road. Utilize detention credits and/ or provide detention delta to meet total detention required.
2	Maximize detention underneath parking garage and hardscape areas.
3	Connect to water mains on Cambridge Street and East Road to create water loop. Provide two water service points of connections for each building where required.

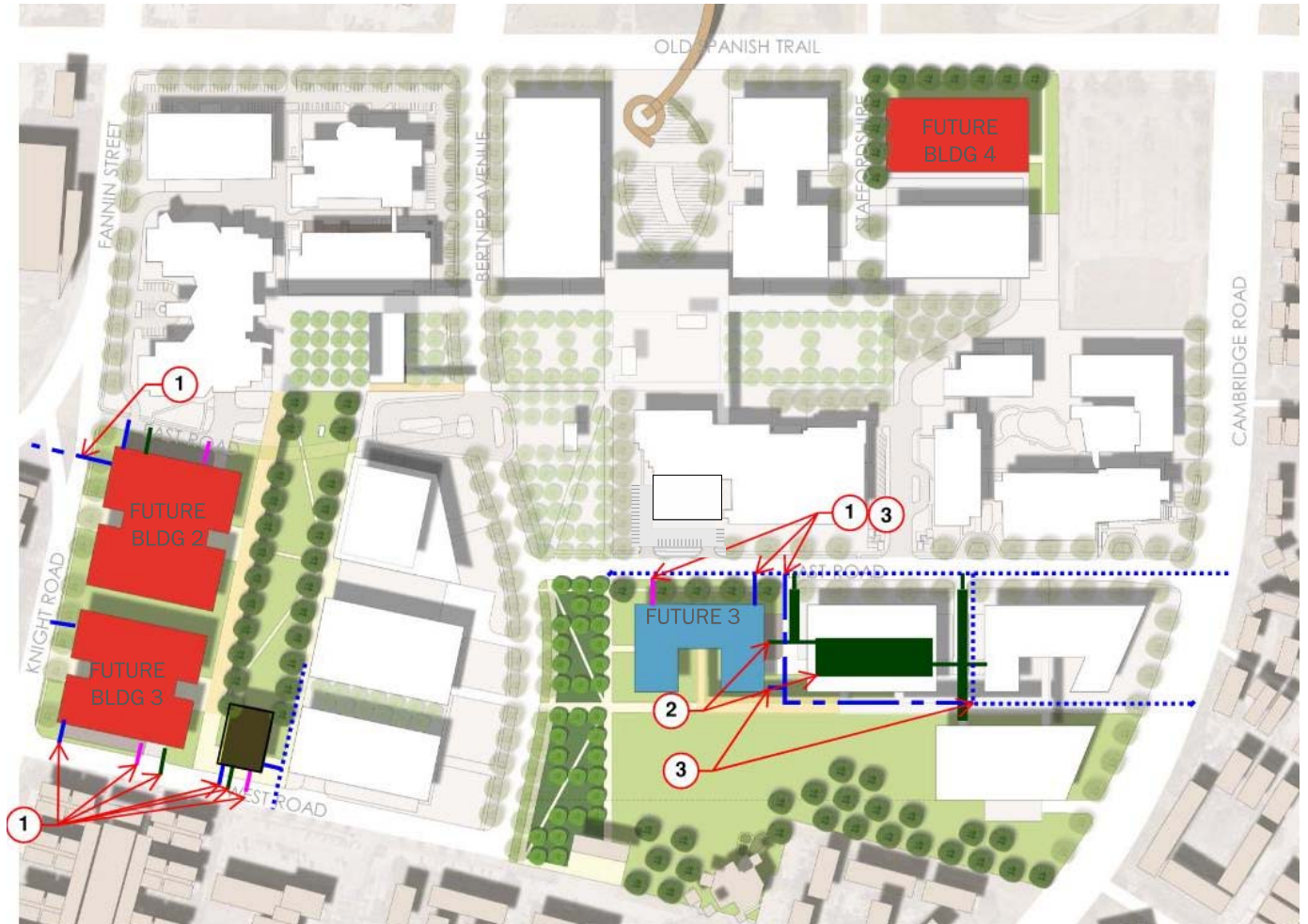

Infrastructure Design Requirements

The site is located within the City of Houston (COH); therefore, any development connecting to City infrastructure would be required to meet criteria presented in the latest COH Infrastructure Design Manual (IDM), COH Code of Ordinances, and Harris County Flood Control District (HCFCD).

Floodplain Requirements:

- Critical facilities located within the 500-year floodplain will be developed 3 feet above the FEMA 500-year elevation
- Flood mitigation will be required within the effective floodplain

Site Utilities:

- Any public utility connections will need to be coordinated with the City of Houston Public Works

Sanitary Sewer Requirements:

- Any connection point must be in conformance with the requirements set forth by the WCR letter issued by the COH
- Minimum diameter of 6" and be constructed of SDR 26 PVC for diameters of 6-10" and SDR 35 for diameters of 12"-15"
- Top of the pipe must be a minimum of 3' below the surface of the natural ground without side ditches
- Distance between manholes must be maintained per Table 1
- Slope must have a minimum full pipe velocity no less than 2.3 feet per second (fps) and maximum velocity must not exceed 4.5 fps, as shown in Table 2

Water Requirements:

- Any connection point must be in conformance with the requirements set forth by the WCR letter issued by the COH
- 4' minimum depth-of-cover over the top of waterline
- For line diameters between 4-12", valves are to be spaced at a maximum distance of 1,000'
- Outdoor backflow prevention must be above-grade or in a sub-grade vault
- Double check valve backflow preventer required for any interior building fire suppression systems

Storm Requirements:

- Any connection point must be in conformance with the requirements set forth by the WCR process issued by the COH
- 12" minimum pipe where applicable for civil
- 18" and above pipes must be constructed of reinforced concrete (RCP) or high-density polyethylene (HCPE)

Storm Water Pollution Prevention Requirements:

- Erosion control measures must be taken during all stages of construction

**Table 8.2
MAXIMUM DISTANCE BETWEEN
SANITARY SEWER MANHOLES**

PIPE DIAMETER (I.D.) IN INCHES	MANHOLE MAXIMUM SPACING IN FEET
8-15	400
18-48	800
Greater than 48	As approved by the City

Table 1. Maximum Distance Between Sanitary Sewer Manholes, COH IDM, 2020

**Table 8.1
GRADES FOR WASTEWATER LINES**

NOMINAL INTERNAL PIPE DIAMETER (INCHES)	MINIMUM GRADE TO DEVELOP V= 2.3 FPS (PERCENT)	MAXIMUM GRADE TO DEVELOP V=4.5 FPS (PERCENT)
6	0.70	2.46
8	0.44	1.73
10	0.33	1.21
12	0.26	0.97
15	0.19	0.72
18	0.15	0.57
21	0.13	0.46
24	0.11	0.38
27	0.09	0.33

Table 2. Grades for Wastewater Lines, COH IDM, 2020

Detention Infrastructure Design

Per City of Houston storm water detention is required for developments that include disturbed area resulting in impervious surface. Therefore, providing detention is expected as the master plan improvements and additions are implemented.

Proposed detention strategy will be to place detention systems under parking garages, roads, and/or other hardscape areas as much as possible. Existing detention can be credited as site develops and master plan improvements are implemented. Any existing detention that is removed will need to be replaced meeting the detention requirements at the time of permitting.

City of Houston Requirements:

The latest City of Houston detention criteria for a tract size equal or greater than 1 acre and less than or equal to 20 acres is based on a sliding scale with the detention rate minimum of 0.75 ac-ft/ac. The detention volume will be required at the acre feet per acre of disturbed area that results in impervious surface as depicted in Figure 3.

Harris County Flood Control District Requirements:

For tract sizes greater than 20 acres, detention calculations will be per the most current version of the Harris County Flood Control District (HCFCD) Policy Criteria and Procedures Manual (PCPM). The minimum detention rate is 0.65 ac-ft/ac for tract sizes 20-640 acres per the HCFCD PCPM and as shown in Figure 4. If a 0.2% (500-year) analysis is required, the 0.2% (500-year) detention rate may be higher than the minimum shown for the 1% (100 year) event.

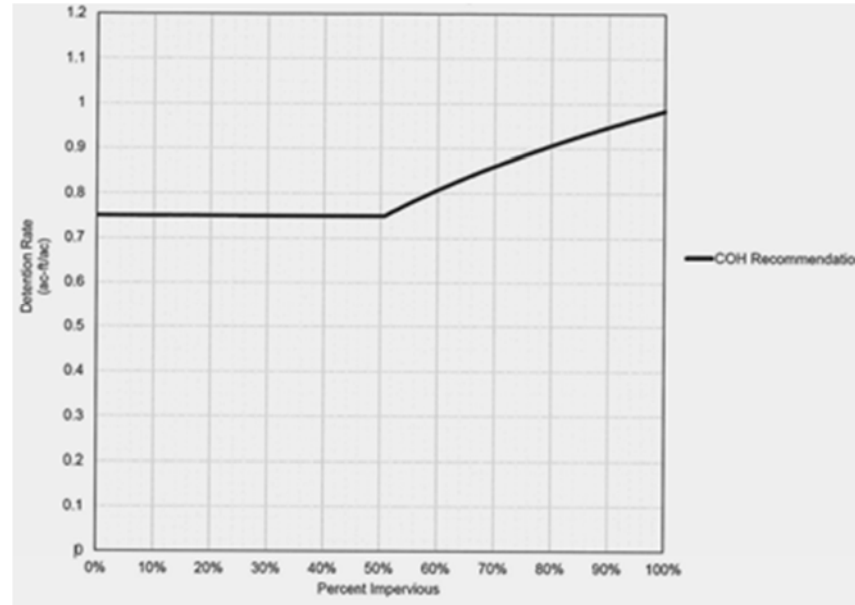

Figure 3. City of Houston Detention Rate vs. Percent Impervious

Detention Rate Increases (100-Year Rate Shown)				
Hydrologic Method	Current Criteria - Size of Project (Acres)	New Criteria - Size of Project (Acres)	Current Minimum Detention Rate (Ac-ft/ac)	New Minimum Detention Rate (Ac-ft/ac)
1	0-50	0-20	0.55	0.65
2	50-640	20-640	0.55	0.65
3	> 640	> 640	0.45	0.55
Pumped	N/A	N/A	0.75	0.75

Figure 4. Harris County Flood District Policy and Procedures Manual Detention Rates

Appendix H
South Campus Master Framework
Parking Study



LJ23

BUILDING	PROJECTED PARKING DEMAND
South Campus Future Building 1	225
South Campus Future Building 2	212
South Campus Future Building 3	505
South Campus Future Building 4	296
Modular Lab	50
Proton Therapy	159
Smith Research Building	147
Operations and Maintenance	51
Physical Plant and Police Offices	178
TOTAL	1,823

At the MD Anderson South Campus there are currently 1,801 parking spaces disbursed among the parking garage and lots. The projected parking demand for this campus, when all buildings are 100% occupied, is approximately 1,823 spaces. The parking system is currently efficient and able to meet the needs of the campus.



LJ23

[@Barnard, Jennifer] - Does this table and all the tables on the subsequent pages need to follow our updated visualization standards (i.e. avoid banded rows)?
Lutz, Jarntip, 3/30/2021

2. Analyze – Existing Conditions

BUILDING	PROJECTED PARKING DEMAND
South Campus Future Building 1	225
South Campus Future Building 2	212
South Campus Future Building 3	505
South Campus Future Building 4	296
Modular Lab	50
Proton Therapy	159
Smith Research Building	147
Operations and Maintenance	51
Physical Plant and Police Offices	178
UT Heath Dental School	724
UTHealth Science Center	190
TOTAL	2,737

The full South Campus includes properties owned by both MD Anderson and UTHealth. The full campus has 2,150 parking spaces disbursed among the MD Anderson and UTHealth parking garage and lots. The projected parking demand for this campus, when all buildings are 100% occupied, is approximately 2,737 spaces. The parking system is currently efficient and able to meet the needs of the full campus.

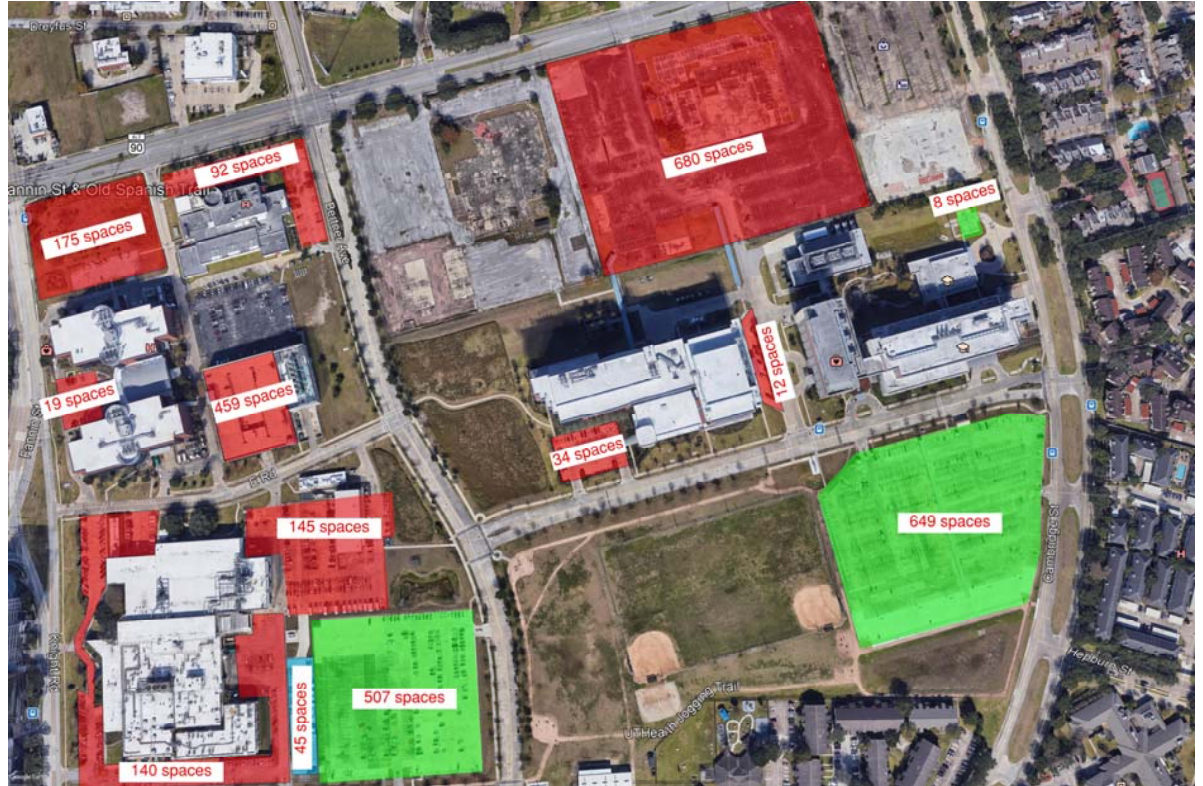

Parking Key Findings

Aggressive Reduction **12.3%**

- Assuming that the employees elected to work remotely 0-2 days a week will not be on site during peak demand

Mid-Level Reduction **7.3%**

- Assuming that half of the employees electing to work remotely one to two days a week will be on site during peak demand
- Employees electing to work remotely full time will not be on site during peak demand

Conservative Reduction **2.2%**

- Employees electing to work remotely full time will not be on site during peak demand

Hyper-Aggressive Reduction **27.2%**

- Requires staggered, assigned bi-weekly work schedule
- Assuming ½ of personnel in 1-59% column will be on site Monday, Wednesday, Friday every other week
- Assuming ½ of personnel in 60-99% column will be onsite Tuesday and Thursday
- Employees electing to work remotely full time will not be on site during peak demand

As part of the parking analysis, our group reviewed the effect of remote work on the future MD Anderson parking demand. MD Anderson is currently reviewing the opportunity for remote work on each campus and has collected data from each department regarding their employee's desire to work remotely, either full time or part time. We gathered the responses received from each person currently on South Campus (shown on righthand table) and analyzed the future parking demand based on four different reduction scenarios, shown below. Each milestone parking demand analysis considers these remote work reductions to gain an understanding if there is opportunity for parking demand reduction in the future.

SOUTH CAMPUS EMPLOYEE REMOTE WORK ELECTIONS (AS OF 09/28/20)

	0% Effort	1-59% Effort	60-99% Effort	100% Effort	Total
Average number of days employee will be in the office	5 days	3-4 days	1-2 days	0 days	
Total Effort	696	359	121	27	1,203
Percent of Employees	57.9%	29.8%	10.1%	2.2%	

5 Year Master Plan (MD Anderson and UTHealth Education Bldg..)

4. Visualize – Proposed Future State

Considering the planned changes in the 5-Year Master Plan, the parking demand for South Campus is projected to be 4,085 spaces.

When the new buildings are constructed some of the current parking supply will be removed, as shown in the following graphic. Additionally, the Proton Therapy 2 lot will be added to the supply.

BUILDING	PROGRAM	PROGRAM USE	PROJECTED PARKING DEMAND
Current Parking Demand	N/A	N/A	1,823
Proton Therapy Phase 2	42,337 USF	Patient Care	72
South Campus Research Building 5	396,000 USF ⁽¹⁾	Research/Lab	792
Vivarium	150,000 USF ⁽²⁾	Vivarium	150
MD Anderson Education Bldg..	165,000 USF ⁽¹⁾	Education	660
UTH Education Bldg..	196,000 USF ⁽³⁾	Education/Research	588
TOTAL			4,085

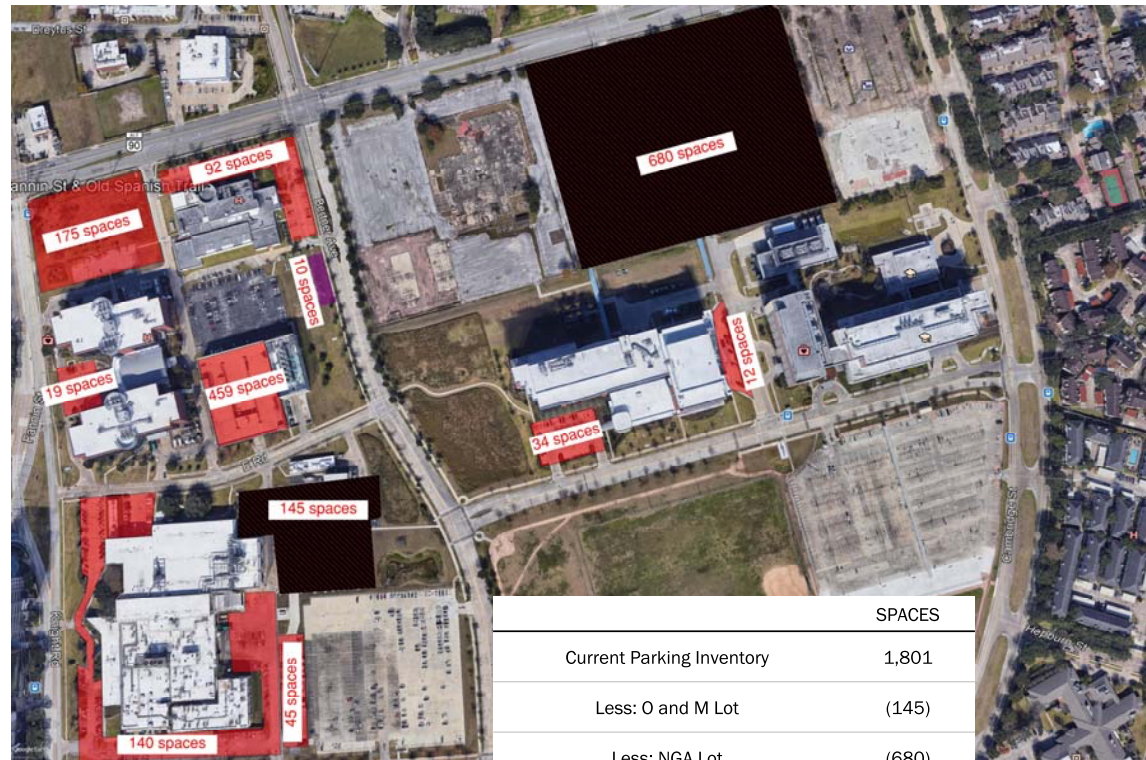

	SPACES
Current Parking Inventory	1,801
Less: O and M Lot	(145)
Less: NGA Lot	(680)
Add: Proton Therapy 2 Lot	10
Revised Parking Inventory	986

⁽¹⁾ Usable Square Footage for SCRB 5 and Education building calculated by reducing the BSF by the average building gross factor of the four existing SCRB's (66%)

⁽²⁾ Usable Square Footage for the Vivarium provided by CannonDesign

⁽³⁾ Usable Square Footage for UTHealth building derived from "South Campus Research Building with SRB – Page Program Summary"

5 Year Master Plan (MD Anderson and UTHealth Education Bldg..)

4. Visualize – Proposed Future State

Once the buildings in the 5-Year Master Plan have been constructed and the parking inventory reduced, the parking system is projected to have a (3,099) space deficit.

	PARKING SPACES
Future Campus Parking Demand ⁽¹⁾	4,085 ⁽²⁾
Future Parking Supply	986
Parking Surplus/Deficit	(3,099)

⁽¹⁾ Assumes full building occupancy and does not consider the effect of remote work

⁽²⁾ Parking demand includes new UTHealth building and excludes existing buildings

When the four different remote work scenarios are applied to the 5-Year demand, we find the following results.

	DEMAND	SUPPLY	SURPLUS/ DEFICIT
Unadjusted	4,085	986	(3,099)
Aggressive – 12.3%	3,655	986	(2,669)
Mid-Level – 7.3%	3,831	986	(2,845)
Conservative – 2.2%	4,007	986	(3,021)
Ultra-Aggressive – 27.2%	3,134	986	(2,148)

Within the 5-Year timeframe a 1,700-space garage is planned for the northeast side of the campus (SC#2 Garage). Once this garage is constructed, the projected parking deficit is reduced to (1,399) spaces.

	PARKING SPACES
Future Campus Parking Demand	4,085
Future Parking Supply ⁽¹⁾	2,686
Parking Surplus/Deficit	(1,399)

⁽¹⁾ Addition of SC#2 Garage. Assuming 1,700 parking spaces, as currently being considered by the garage design team.

Including the addition of the 1,700-space SC#2 Garage in the remote work analysis we project the following parking system deficit.

	DEMAND	SUPPLY	SURPLUS/ DEFICIT
Unadjusted	4,085	2,686	(1,399)
Aggressive – 12.3%	3,655	2,686	(969)
Mid-Level – 7.3%	3,831	2,686	(1,145)
Conservative – 2.2%	4,007	2,686	(1,321)
Ultra-Aggressive – 27.2%	3,134	2,686	(448)

Based on discussions with MD Anderson, the range of spaces for the SC#2 Garage for the 5-year phase master plan to be between 1,700 to 2,200 car capacity.

15 Year Master Plan (MD Anderson Only)

4. Visualize – Proposed Future State

Considering the planned changes in the 15-Year Master Plan for MD Anderson sites only, the parking demand for South Campus is projected to be 3,975 spaces.

When the 15-Year Master Plan buildings are constructed most of the current parking supply will be removed, as shown in the following graphic. During the 5-Year buildout the 1,700-space garage will be constructed, adding inventory to the parking system. The total parking inventory at the beginning of the 15-Year build out is 1,867 spaces.

BUILDING	PROGRAM	PROGRAM USE	PROJECTED PARKING DEMAND
Current Parking Demand	N/A	N/A	1,823
5-Year Master Plan Parking Demand	N/A	N/A	1,674
Future Needs Building 1	237,600 USF ⁽¹⁾	Research/Lab	475
Proton Therapy Phase Three ⁽²⁾	130,000 USF	Patient Care	150
Smith Research Building Demo	N/A	Research/Lab	(147)
TOTAL			3,975

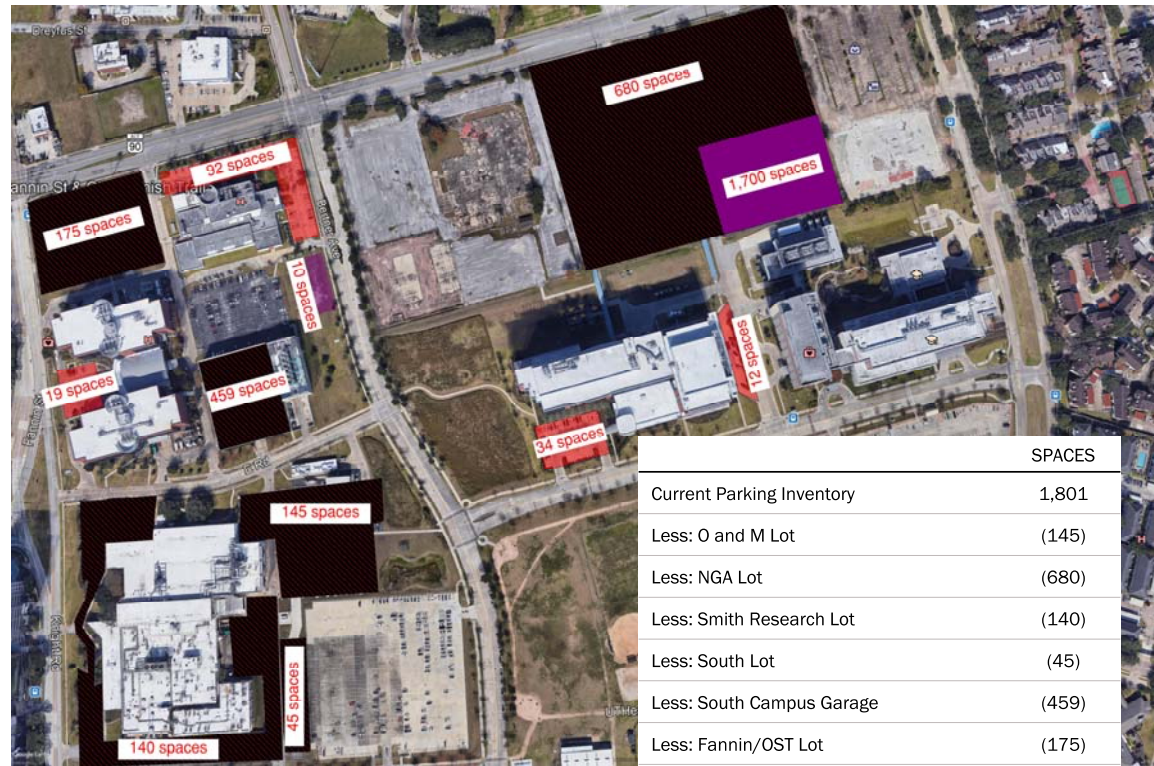

⁽¹⁾ Usable Square Footage for Research 1 building calculated by reducing the BSF by the average building gross factor of the four existing SCRB's (66%)

⁽²⁾ Assumption based upon total projected employees and patients. May change based on actual square footage of building.

⁽³⁾ Parking demand will decrease if valet services are utilized for the building.

15 Year Master Plan (MD Anderson Only)

Once the buildings in the 15-Year Master Plan have been constructed and the parking inventory reduced, the parking system is projected to have a (2,108) space deficit.

	PARKING SPACES
Future MD Anderson Parking Demand ⁽¹⁾	3,975
Future Parking Supply	1,867
Parking Surplus/Deficit	(2,108)

⁽¹⁾ Assumes full building occupancy and does not consider the effect of remote work

When the four different remote work scenarios are applied to the 15-Year demand, we find the following results.

	DEMAND	SUPPLY	SURPLUS/ DEFICIT
Unadjusted	3,975	1,867	(2,108)
Aggressive – 12.3%	3,486	1,867	(1,619)
Mid-Level – 7.3%	3,686	1,867	(1,819)
Conservative – 2.2%	3,886	1,867	(2,019)
Ultra-Aggressive – 27.2%	2,894	1,867	(1,027)

Within the 15-Year timeframe a 1,450-space garage is planned for the southwest side of the campus (Research Garage) and approximately 50 spaces are planned for the Proton Therapy Three site. Once this new inventory is added, the projected parking deficit is reduced to (608) spaces.

	PARKING SPACES
Future MD Anderson Parking Demand	3,975
Future Parking Supply ⁽¹⁾	3,367
Parking Surplus/Deficit	(608)

⁽¹⁾ Addition of Research Garage (1,450 spaces) and PT3 Lot (50 spaces)

Including the addition of the 1,450-space Research Garage and the PT3 lot in the remote work analysis we project the following parking system deficit/surplus.

	DEMAND	SUPPLY	SURPLUS/ DEFICIT
Unadjusted	3,975	3,367	(608)
Aggressive – 12.3%	3,486	3,367	(119)
Mid-Level – 7.3%	3,686	3,367	(319)
Conservative – 2.2%	3,886	3,367	(519)
Ultra-Aggressive – 27.2%	2,894	3,367	473

30 Year Master Plan (MD Anderson Only)

4. Visualize – Proposed Future State

Considering the planned changes in the 30-Year Master Plan for MD Anderson sites only, the parking demand for South Campus is projected to be 5,706 spaces.

During the 15-Year buildout the 1,450-space Research Garage will be constructed as well as the fifty parking spaces around Proton Therapy Phase Three, adding inventory to the parking system. The total parking inventory at the beginning of the 30-Year build out is 3,367 spaces.

BUILDING	PROGRAM	PROGRAM USE	PROJECTED PARKING DEM AND
Current Parking Demand	N/A	N/A	1,823
5-Year Master Plan Parking Demand	N/A	N/A	1,674
15-Year Master Plan Parking Demand	N/A	N/A	478
Future Needs Building 2	376,200 USF ⁽¹⁾	Research/Lab	752
Future Needs Building 3	237,600 USF ⁽¹⁾	Research/Lab	475
Future Needs Building 4	201,600 USF ⁽²⁾	Administration	504
Total			5,706

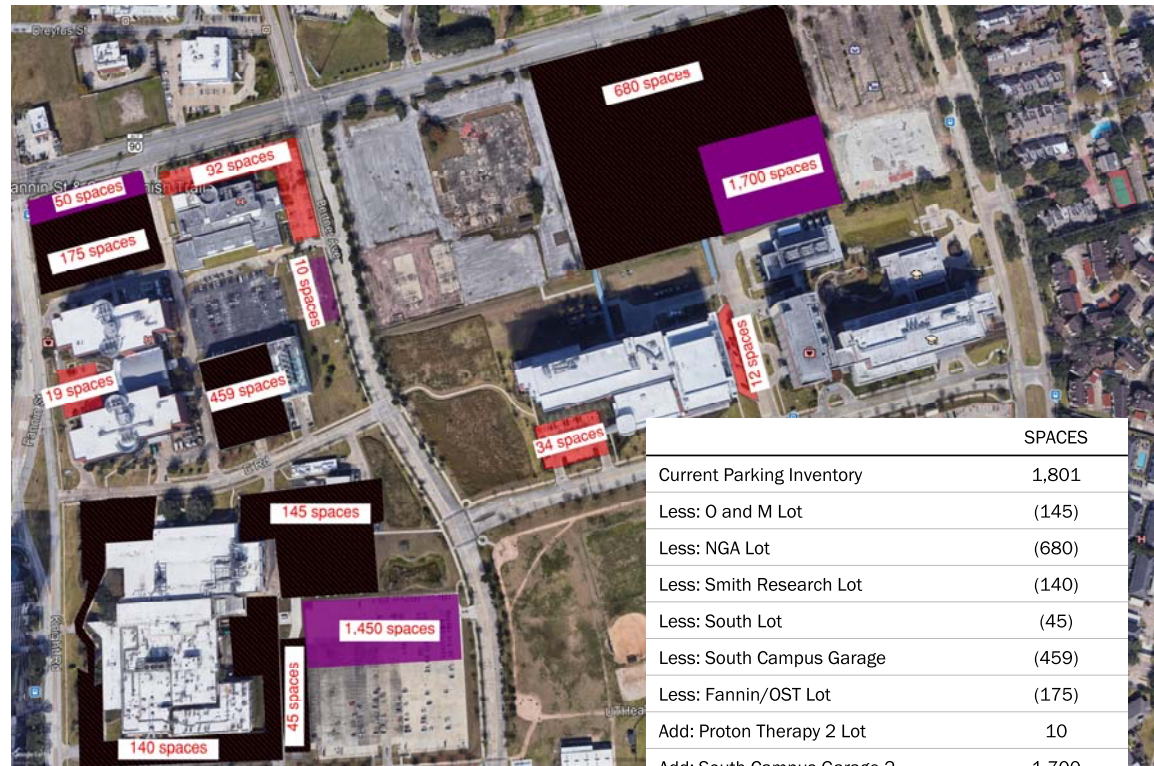

	SPACES
Current Parking Inventory	1,801
Less: O and M Lot	(145)
Less: NGA Lot	(680)
Less: Smith Research Lot	(140)
Less: South Lot	(45)
Less: South Campus Garage	(459)
Less: Fannin/OST Lot	(175)
Add: Proton Therapy 2 Lot	10
Add: South Campus Garage 2	1,700
Add: Proton Therapy 3 Lot	50
Add: Research Garage	1,450
Revised Parking Inventory	3,367

⁽¹⁾ Usable Square Footage for Research buildings calculated by reducing the BSF by the average building gross factor of the four existing SCRB's (66%)

⁽²⁾ Usable Square Footage for MD Anderson Building calculated by reducing the BSF by the building gross factor of the existing MC1 Administration building (56%)

30 Year Master Plan (MD Anderson Only)

Once the buildings in the 30-Year Master Plan have been constructed and the parking inventory reduced, the parking system is projected to have a (2,339) space deficit.

	PARKING SPACES
Future MD Anderson Parking Demand ⁽¹⁾	5,706
Future Parking Supply ⁽²⁾	3,367
Parking Surplus/Deficit	(2,339)

⁽¹⁾ Assumes full building occupancy and does not consider the effect of remote work

⁽²⁾ Assumes planned inventory for Proton Therapy Phase 2 and 3 Lot, SC#2 garage and Research garage

When the four different remote work scenarios are applied to the 30-Year demand, we find the following results.

	DEMAND	SUPPLY	SURPLUS/ DEFICIT
Unadjusted	5,706	3,367	(2,339)
Aggressive – 12.3%	5,004	3,367	(1,637)
Mid-Level – 7.3%	5,291	3,367	(1,924)
Conservative – 2.2%	5,578	3,367	(2,211)
Ultra-Aggressive – 27.2%	4,154	3,367	(787)

5 Year Master Plan (Full Campus, Inclusive of UTHealth)

4. Visualize – Proposed Future State

Considering the planned changes in the 5-Year Master Plan and the current UTHealth demand, the parking demand for the full South Campus is projected to be 4,999 spaces.

When the new buildings are constructed some of the current parking supply will be removed, as shown in the following graphic. Additionally, the Proton Therapy 2 lot will be added to the supply.

BUILDING	PROGRAM	PROGRAM USE	PROJECTED PARKING DEMAND
Current MD Anderson Parking Demand	N/A	N/A	1,823
Proton Therapy Phase 2	42,337 USF	Patient Care	72
South Campus Research Building 5	396,000 USF	Research/Lab	792
Vivarium	150,000 USF	Vivarium	150
MD Anderson Education Bldg..	165,000 USF	Education	660
UTHealth Education Bldg..	196,000 USF	Education/Research	588
UT Dental School ⁽¹⁾	180,991 NASF ⁽²⁾	Education	724
UTHealth Science Center ⁽¹⁾	91,863 NASF ⁽²⁾	Research/Lab and Admin.	190
Total			4,999

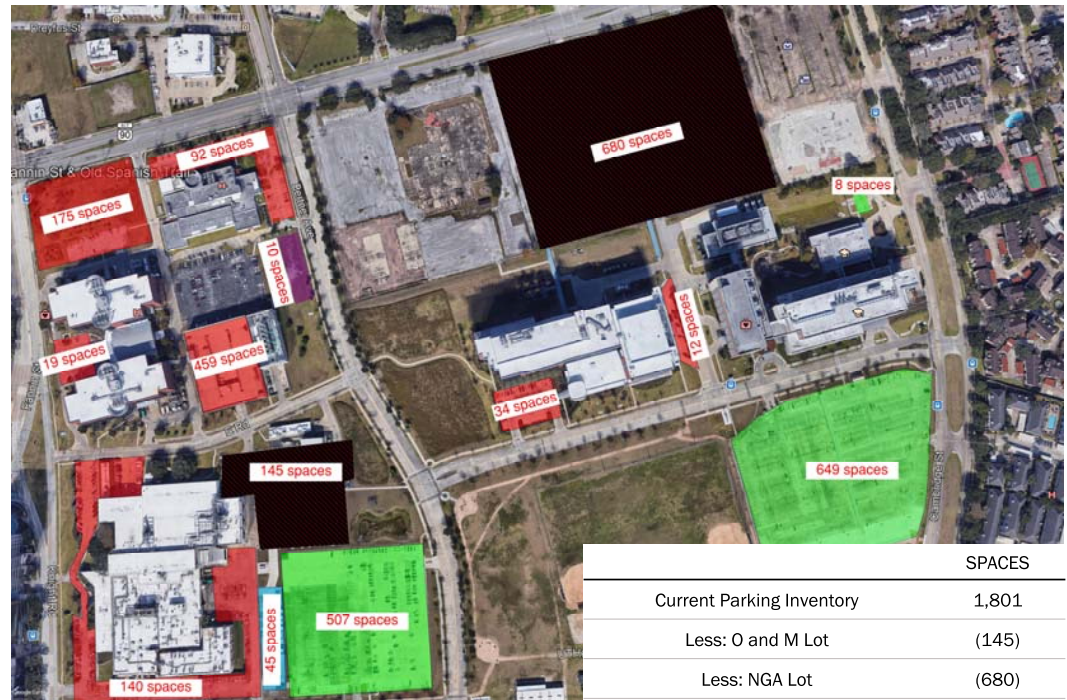

	SPACES
Current Parking Inventory	1,801
Less: O and M Lot	(145)
Less: NGA Lot	(680)
Add: Proton Therapy 2 Lot	10
Add: UTHealth Lot	649
Add: UTHealth West Lot	507
Add: UTHealth Cooley Lot	8
Revised Parking Inventory	2,150

⁽¹⁾ Program derived from Texas Higher Education Coordinating Board Campus Planning website

⁽²⁾ NASF = The sum of all areas within the interior walls of rooms on all floors of a building assigned to, or available for assignment to, an occupant or use, excluding unassigned areas. NASF includes auxiliary space and education and general space.

5 Year Master Plan (Full Campus, Inclusive of UTHealth)

Once the buildings in the 5-Year Master Plan have been constructed and the parking inventory reduced; the parking system is projected to have a (2,849) space deficit.

	PARKING SPACES
Future Campus Parking Demand ⁽¹⁾	4,999
Future Parking Supply	2,150
Parking Surplus/Deficit	(2,849)

⁽¹⁾Assumes full building occupancy and does not consider the effect of remote work

When the four different remote work scenarios are applied to the 5-Year demand, we find the following results. Remote work reductions were not applied to UTHealth program as their remote work status is unknown.

	DEMAND	SUPPLY	SURPLUS/ DEFICIT
Unadjusted	4,999	2,150	(2,849)
Aggressive – 12.3%	4,569	2,150	(2,419)
Mid-Level – 7.3%	4,745	2,150	(2,595)
Conservative – 2.2%	4,921	2,150	(2,771)
Ultra-Aggressive – 27.2%	4,048	2,150	(1,898)

Within the 5-Year timeframe a 1,700-space garage is planned for the northeast side of the campus (SC#2 Garage). Once this garage is constructed the projected parking deficit is reduced to (1,149) spaces.

	PARKING SPACES
Future Campus Parking Demand	4,999
Future Parking Supply ⁽¹⁾	3,850
Parking Surplus/Deficit	(1,149)

⁽¹⁾Addition of SC#2 Garage. Assuming 1,700 parking spaces, as currently being considered by the garage design team.

Including the addition of the 1,700-space SC#2 Garage in the remote work analysis we project the following parking system deficit.

	DEMAND	SUPPLY	SURPLUS/ DEFICIT
Unadjusted	4,999	3,850	(1,149)
Aggressive – 12.3%	4,569	3,850	(719)
Mid-Level – 7.3%	4,745	3,850	(895)
Conservative – 2.2%	4,921	3,850	(1,071)
Ultra-Aggressive – 27.2%	4,048	3,850	(198)

15 Year Master Plan (Full Campus, Inclusive of UTHealth)

4. Visualize – Proposed Future State

Considering the planned changes in the 15-Year Master Plan for the entire campus, the parking demand for South Campus is projected to be 6,550 spaces.

When the 15-Year Master Plan buildings are constructed most of the current parking supply will be removed, as shown in the following graphic. During the 5-Year buildout the 1,700-space garage will be constructed, adding inventory to the parking system. Additionally, as part of Phase One in the 15-Year build out for UTH, a 1,500-space parking garage will be constructed. The total parking inventory at the beginning of the 15-Year build out is 3,375 spaces.

BUILDING	PROGRAM	PROGRAM USE	PROJECTED PARKING DEMAND
Current MD Anderson Parking Demand	N/A	N/A	1,823
Current UTHealth Parking Demand	N/A	N/A	914
5-Year Master Plan (MD Anderson) Parking Demand	N/A	N/A	1,674
5-Year Master Plan (UTHealth) Parking Demand	N/A	N/A	588
Future Needs Building 1	237,600 USF	Research/Lab	475
Proton Therapy Phase Three	130,000 USF	Patient Care	150
Smith Research Building Demo	N/A	Research/Lab	(147)
UTHealth Future Needs Building 1	195,000 USF ⁽¹⁾	Research/Lab	390
UTHealth Future Needs Building 2	195,000 USF ⁽¹⁾	Research/Lab	390
UTHealth Expansion – L-Building	146,250 USF ⁽²⁾	Research/Lab	293
Total			6,550

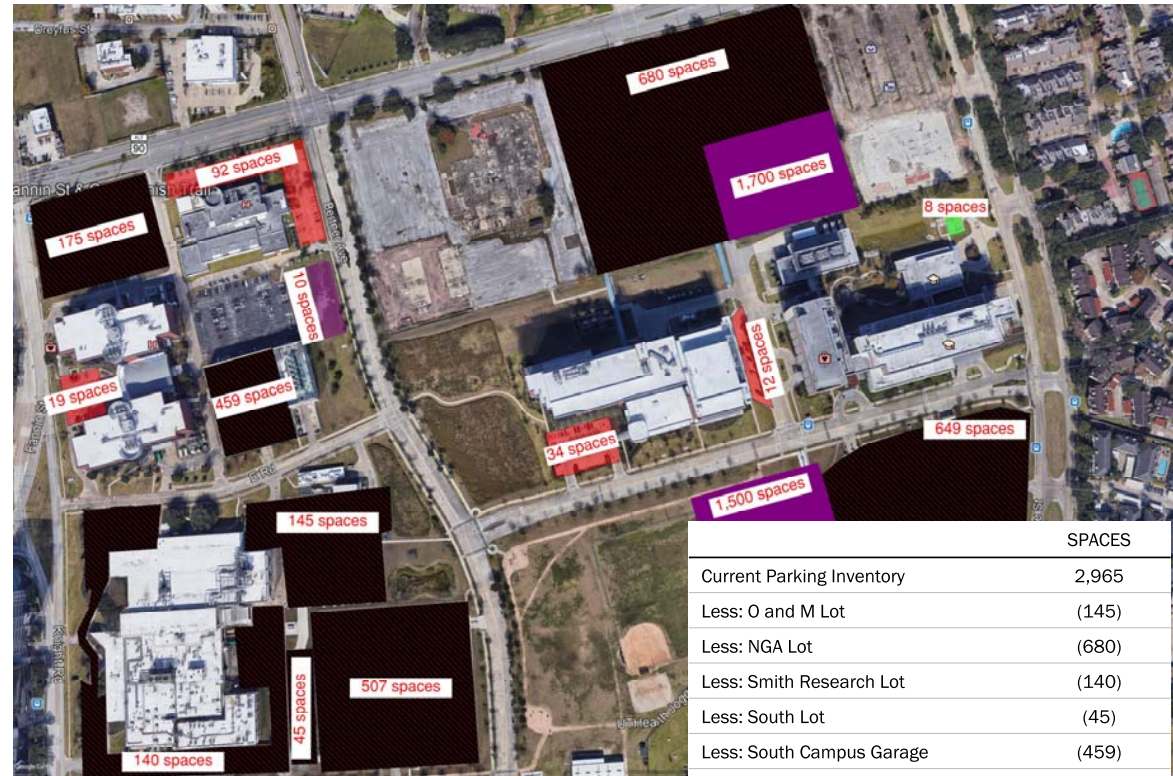

	SPACES
Current Parking Inventory	2,965
Less: O and M Lot	(145)
Less: NGA Lot	(680)
Less: Smith Research Lot	(140)
Less: South Lot	(45)
Less: South Campus Garage	(459)
Less: Fannin/OST Lot	(175)
Less: UTHealth Lot	(649)
Less: UTHealth West Lot	(507)
Add: Proton Therapy 2 Lot	10
Add: South Campus Garage 2	1,700
Add: UTHealth Garage	1,500
Revised Parking Inventory	3,375

⁽¹⁾ Usable Square Footage for UTHealth building calculated by reducing the BSF by the proposed building gross factor of the UTHealth Building in the 5-Year Plan (65%)

⁽²⁾ Size of the UTHealth Expansion L-Building is not currently known. For calculation purposes assumed it was ¾ the size of the planned research buildings.

15 Year Master Plan (Full Campus, Inclusive of UTHealth)

Once the buildings in the 15-Year Master Plan have been constructed for both MD Anderson and UTHealth, and the parking inventory updated, the parking system is projected to have a (3,175) space deficit.

	PARKING SPACES
Future Campus Parking Demand ⁽¹⁾	6,550
Future Parking Supply ⁽²⁾	3,375
Parking Surplus/Deficit	(3,175)

⁽¹⁾ Assumes full building occupancy and does not consider the effect of remote work

⁽²⁾ Supply includes UTHealth South Campus Garage as it is planned to be built at the beginning of the 15-Year buildout

When the four different remote work scenarios are applied to the 15-Year demand, we find the following results. Remote work reductions were not applied to UTHealth program as their remote work status is unknown.

	DEMAND	SUPPLY	SURPLUS/ DEFICIT
Unadjusted	6,550	3,375	(3,175)
Aggressive – 12.3%	6,061	3,375	(2,686)
Mid-Level – 7.3%	6,261	3,375	(2,886)
Conservative – 2.2%	6,461	3,375	(3,086)
Ultra-Aggressive – 27.2%	5,469	3,375	(2,094)

Within the 15-Year timeframe a 1,450-space garage is planned for the southwest side of the campus (Research Garage) and approximately 50 spaces are planned for the Proton Therapy Three site. Once this new inventory is added, the projected parking deficit is reduced to (1,675) spaces.

	PARKING SPACES
Future Campus Parking Demand	6,550
Future Parking Supply ⁽¹⁾	4,875
Parking Surplus/Deficit	(1,675)

⁽¹⁾ Addition of Research Garage (1,450 spaces) and PT3 Lot (50 spaces)

Including the addition of the 1,450-space Research Garage and the PT3 lot in the remote work analysis we project the following parking system deficit.

	DEMAND	SUPPLY	SURPLUS/ DEFICIT
Unadjusted	6,550	4,875	(1,675)
Aggressive – 12.3%	6,061	4,875	(1,186)
Mid-Level – 7.3%	6,261	4,875	(1,386)
Conservative – 2.2%	6,461	4,875	(1,586)
Ultra-Aggressive – 27.2%	5,469	4,875	(594)

30 Year Master Plan (Full Campus, Inclusive of UTHealth)

4. Visualize – Proposed Future State

Considering the planned changes in the 30-Year Master Plan for both the MD Anderson and UTHealth sites, the parking demand for South Campus is projected to be 8,671 spaces.

During the 15-Year buildout the 1,450-space MD Anderson Research Garage will be constructed as well as the fifty parking spaces around Proton Therapy Phase Three. Additionally, the 1500-space UTHealth garage will be added to the inventory. The total parking inventory at the beginning of the 30-Year build out is 4,875 spaces.

BUILDING	PROGRAM	PROGRAM USE	PROJECTED PARKING DEMAND
Current MD Anderson Parking Demand	N/A	N/A	1,823
Current UTHealth Parking Demand	N/A	N/A	914
5-Year Master Plan (MD Anderson) Parking Demand	N/A	N/A	1,674
5-Year Master Plan (UTHealth) Parking Demand	N/A	N/A	588
15-Year Master Plan (MD Anderson) Parking Demand	N/A	N/A	478
15-Year Master Plan (UTHealth) Parking Demand	N/A	N/A	1,073
MD Anderson Future Needs Building 4	201,600 USF	Administration	504
MD Anderson Future Needs Building 2	376,200 USF	Research/Lab	752
MD Anderson Future Needs Building 3	237,600 USF	Research/Lab	475
UTHealth Future Needs Building 3	195,000 USF ⁽¹⁾	Research/Lab	390
Total			8,671



	SPACES
Current Parking Inventory	2,965
Less: O and M Lot	(145)
Less: NGA Lot	(680)
Less: Smith Research Lot	(140)
Less: South Lot	(45)
Less: South Campus Garage	(459)
Less: Fannin/OST Lot	(175)
Less: UTHealth Lot	(649)
Less: UTHealth West Lot	(507)
Add: Proton Therapy 2 Lot	10
Add: South Campus Garage 2	1,700
Add: Proton Therapy 3 Lot	50
Add: UTHealth Garage	1,500
Add: Research Garage	1,450
Revised Parking Inventory	4,875

⁽¹⁾ Usable Square Footage for UTHealth building calculated by reducing the BSF by the proposed building gross factor of the UTHealth Building in the 5-Year Plan (65%)

30 Year Master Plan (Full Campus, Inclusive of UTHealth)

Once the buildings in the 30-Year Master Plan have been constructed and the parking inventory changed, the parking system is projected to have a (3,796) space deficit.

PARKING SPACES	
Future MD Anderson Parking Demand ⁽¹⁾	8,671
Future Parking Supply ⁽²⁾	4,875
Parking Surplus/Deficit	(3,796)

⁽¹⁾ Assumes full building occupancy and does not consider the effect of remote work

⁽²⁾ Assumes planned inventory for Proton Therapy Phase 2 and 3 Lot, SC#2 garage, Research garage and UTH Garage

When the four different remote work scenarios are applied to the 30-Year demand, we find the following results. Remote work reductions were not applied to UTHealth program as their remote work status is unknown.

	DEMAND	SUPPLY	SURPLUS/ DEFICIT
Unadjusted	8,671	4,875	(3,796)
Aggressive – 12.3%	7,969	4,875	(3,094)
Mid-Level – 7.3%	8,256	4,875	(3,381)
Conservative – 2.2%	8,543	4,875	(3,668)
Ultra-Aggressive – 27.2%	7,119	4,875	(2,244)

Implementation

There are many changes planned to occur within the 5-Year Master Plan including the construction of three new buildings, removal of two parking lots and construction of one new garage. The phasing of these projects will become paramount as planning continues. To assist in the phasing process for the parking inventory we reviewed four different scenarios. The available parking inventory throughout each phase scenario is shown in the table below.

- Scenario 1C – this scenario also considers constructing ½ of the garage sooner (1st qtr. 2023) but also leasing 455 parking spaces from the adjacent landowner in 2022 when the NGA lot comes offline to construct the garage. The second ½ of the garage is planned to be constructed by year 2026.

Detailed information for each scenario can be found in the Additional Documentation pages of this section.

The four different scenarios considered are:

- Base Scenario – in this scenario the SC#2 Garage is completed in the fourth quarter of 2024, as currently planned
- Scenario 1A – this scenario considers the effects of constructing the garage sooner, completing it by the first quarter of 2023
- Scenario 1B – this scenario considers constructing ½ of the garage sooner, in the first quarter of 2023, and constructing the other ½ by 2026 when the parking demand increases

	CURRENT	2021	1 ST QTR. 2022	2 ND QTR. 2022	3 RD QTR. 2022	4 TH QTR. 2022	1 ST QTR. 2023	2 ND QTR. 2023-3 RD QTR. 2024	4 TH QTR. 2024	2025	2026	2027
Base Scenario	(22)	(150)	(150)	(150)	(455)	(600)	(826)	(826)	874	874	(720)	(1,512)
Scenario 1A: Construct Garage Sooner	(22)	(455)	(455)	(455)	(455)	(600)	874	874	874	874	(720)	(1,512)
Scenario 1B: Construct ½ Garage Sooner	(22)	(455)	(455)	(455)	(455)	(600)	24	24	24	24	(720)	(1,512)
Scenario 1C: Construct ½ Garage Sooner and Lease from Kroger	(22)	(455)	0	0	0	(145)	24	24	24	24	(720)	(1,512)

Parking Phasing - Base Program

SC#2 Garage is completed in the fourth quarter of 2024

	DEMAND	DEMAND CHANGE	REASON FOR CHANGE	NEW DEMAND	SUPPLY	SUPPLY CHANGE	REASON FOR CHANGE	NEW SUPPLY	ADEQUACY
Current	1,823			1,823	1,801			1,801	(22)
Year 2021	1,823	72	Proton Therapy 2 Added	1,895	1,801	(56)	Infrastructure Work	1,745	(150)
1 st Qtr. 2022		No Demand Changes		1,895		No Supply Changes		1,745	(150)
2 nd Qtr. 2022		No Demand Changes		1,895		No Supply Changes		1,745	(150)
3 rd Qtr. 2022	1,895	0	N/A	1,895	1,745	(305)	NGA spaces lost to start garage construction	1,440	(455)
4 th Qtr. 2022	1,895	0	N/A	1,895	1,440	(145)	O and M Lot removed for Vivarium	1,295	(600)
1 st Qtr. 2023	1,895	0	N/A	1,895	1,295	(226)	NGA spaces lost to start GSHP/UTH	1,069	(826)
2 nd Qtr. 2023 – 3 rd Qtr. 2024		No Demand Changes		1,895		No Supply Changes		1,069	(826)
4 th Qtr. 2024	1,895	0	N/A	1,895	1,069	1,700	New Garage Complete	2,769	874
Year 2025		No Demand Changes		1,895		No Supply Changes		2,769	874
Year 2026	1,895	1,594	Opening of Vivarium, GSHP/UTH	3,489	2,769	0	0	2,769	(720)
Year 2027	3,489	792	Opening of SCRB 5	4,281	2,769	0	0	2,769	(1,512)

Parking Phasing - Scenario 1A

SC#2 Garage is completed in the first quarter of 2023

	DEMAND	DEMAND CHANGE	REASON FOR CHANGE	NEW DEMAND	SUPPLY	SUPPLY CHANGE	REASON FOR CHANGE	NEW SUPPLY	ADEQUACY
Current	1,823			1,823	1,801			1,801	(33)
Year 2021	1,823	72	Proton Therapy 2 Added	1,895	1,801	(361)	Infrastructure Work (56) and NGA spaces lost to start garage construction (305)	1,440	(455)
1 st Qtr. 2022		No Demand Changes		1,895		No Supply Changes		1,440	(455)
2 nd Qtr. 2022		No Demand Changes		1,895		No Supply Changes		1,440	(455)
3 rd Qtr. 2022		No Demand Changes		1,895		No Supply Changes		1,440	(455)
4 th Qtr. 2022	1,895	0	N/A	1,895	1,440	(145)	O and M Lot removed for Vivarium	1,295	(600)
1 st Qtr. 2023	1,895	0	N/A	1,895	1,295	1,474	NGA spaces lost to start GSHP/UTH (226) and New Garage Complete +1,700	2,769	874
2 nd Qtr.. 2023 – 3 rd Qtr. 2024		No Demand Changes		1,895		No Supply Changes		2,769	874
4 th Qtr.. 2024		No Demand Changes		1,895		No Supply Changes		2,769	874
Year 2025		No Demand Changes		1,895		No Supply Changes		2,769	874
Year 2026	1,895	1,594	Opening of Vivarium, GSHP/UTH	3,489	2,769	0	0	2,769	(720)
Year 2027	3,489	792	Opening of SCRB 5	4,281	2,769	0	0	2,769	(1,512)

Parking Phasing - Scenario 1B

Half of SC#2 Garage is completed in the first quarter of 2023 and the other half is completed in 2026

	DEMAND	DEMAND CHANGE	REASON FOR CHANGE	NEW DEMAND	SUPPLY	SUPPLY CHANGE	REASON FOR CHANGE	NEW SUPPLY	ADEQUACY
Current	1,823			1,823	1,801			1,801	(22)
Year 2021	1,823	72	Proton Therapy 2 Added	1,895	1,801	(361)	Infrastructure Work (56) and NGA spaces lost to start garage construction (305)	1,440	(455)
1 st Qtr. 2022		No Demand Changes		1,895		No Supply Changes		1,440	(455)
2 nd Qtr. 2022		No Demand Changes		1,895		No Supply Changes		1,440	(455)
3 rd Qtr. 2022		No Demand Changes		1,895		No Demand Changes		1,440	(455)
4 th Qtr. 2022	1,895	0	N/A	1,895	1,440	(145)	O and M Lot removed for Vivarium	1,295	(600)
1 st Qtr. 2023	1,895	0	N/A	1,895	1,295	624	NGA spaces lost to start GSHP/UTH (226) and New Garage Complete +850	1,919	24
2 nd Qtr. 2023 – 3 rd Qtr. 2024		No Demand Changes		1,895		No Supply Changes		1,919	24
4 th Qtr.. 2024		No Demand Changes		1,895		No Supply Changes		1,919	24
Year 2025		No Demand Changes		1,895		No Supply Changes		1,919	24
Year 2026	1,895	1,594	Opening of Vivarium, GSHP/UTH	3,489	1,919	850	Second Half of Garage Completed	2,769	(720)
Year 2027	3,489	792	Opening of SCRB 5	4,281	2,769	0	0	2,769	(1,512)

Parking Phasing - Scenario 1C

Half of SC#2 Garage is completed in the first quarter of 2023 and the other half is completed in 2026. In addition, 455 spaces are leased from adjacent landowner when NGA lot is removed from inventory.

	DEMAND	DEMAND CHANGE	REASON FOR CHANGE	NEW DEMAND	SUPPLY	SUPPLY CHANGE	REASON FOR CHANGE	NEW SUPPLY	ADEQUACY
Current	1,823			1,823	1,801			1,801	(22)
Year 2021	1,823	72	Proton Therapy 2 Added	1,895	1,801	(361)	Infrastructure Work (56) and NGA spaces lost to start garage construction (305)	1,440	(455)
1 st Qtr. 2022		No Demand Changes		1,895	1,440	455	Lease Kroger Spaces	1,895	0
2 nd Qtr. 2022		No Demand Changes		1,895		No Supply Changes		1,895	0
3 rd Qtr. 2022		No Demand Changes		1,895		No Demand Changes		1,895	0
4 th Qtr. 2022	1,895	0	N/A	1,895	1,895	(145)	O and M Lot removed for Vivarium	1,750	(145)
1 st Qtr. 2023	1,895	0	N/A	1,895	1,750	169	NGA spaces lost to start GSHP/UTH (226) and New Garage Complete +850; release Kroger spaces (455)	1,919	24
2 nd Qtr. 2023 – 3 rd Qtr. 2024		No Demand Changes		1,895		No Supply Changes		1,919	24
4 th Qtr. 2024		No Demand Changes		1,895		No Supply Changes		1,919	24
Year 2025		No Demand Changes		1,895		No Supply Changes		1,919	24
Year 2026	1,895	1,594	Opening of Vivarium, GSHP/UTH	3,489	1,919	850	Second Half of Garage Completed	2,769	(720)
Year 2027	3,489	792	Opening of SCRB 5	4,281	2,769	0	0	2,769	(1,512)

Walking Distance – Research Garage

The walking distance was calculated from two different site options for the Research Garage, planned within the 15-Year Master Plan. The garage is currently planned on Site A, shown below. The walking distance from this site to the SCR 1 and 2 buildings is approximately 1,070ft, representing a Level of Service B in a covered walkway setting.

The garage is Site B is located on the southern half of the parking lot parcel, as shown in blue below. The walking distance from this site to the SCR 1 and 2 buildings is approximately 1,265ft.. This walking distance represents a Level of Service B-C in a covered walkway setting.

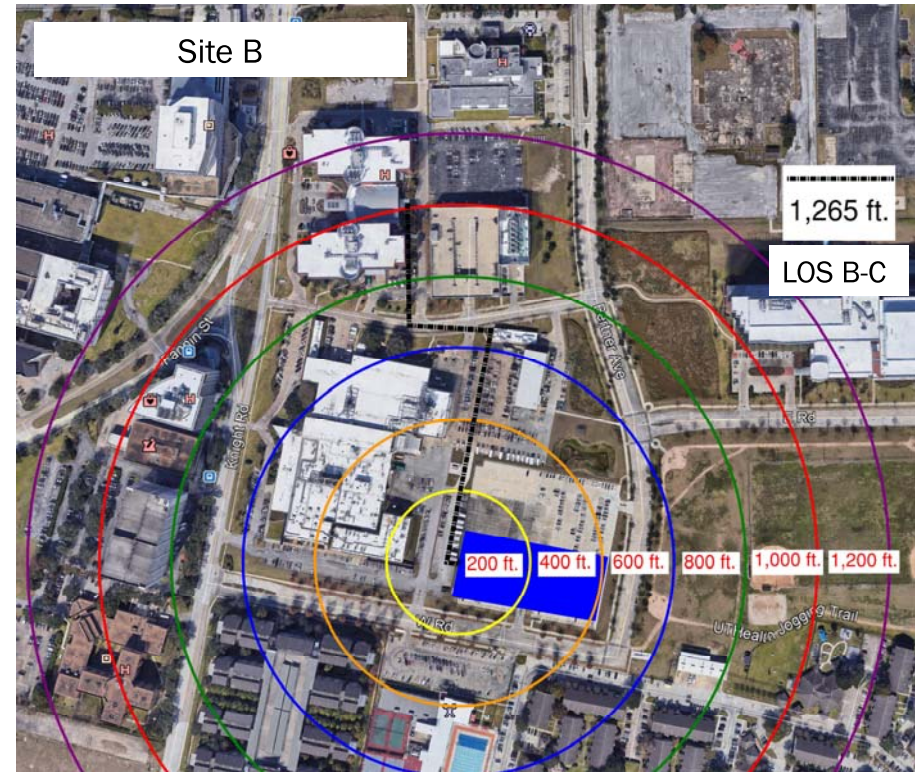
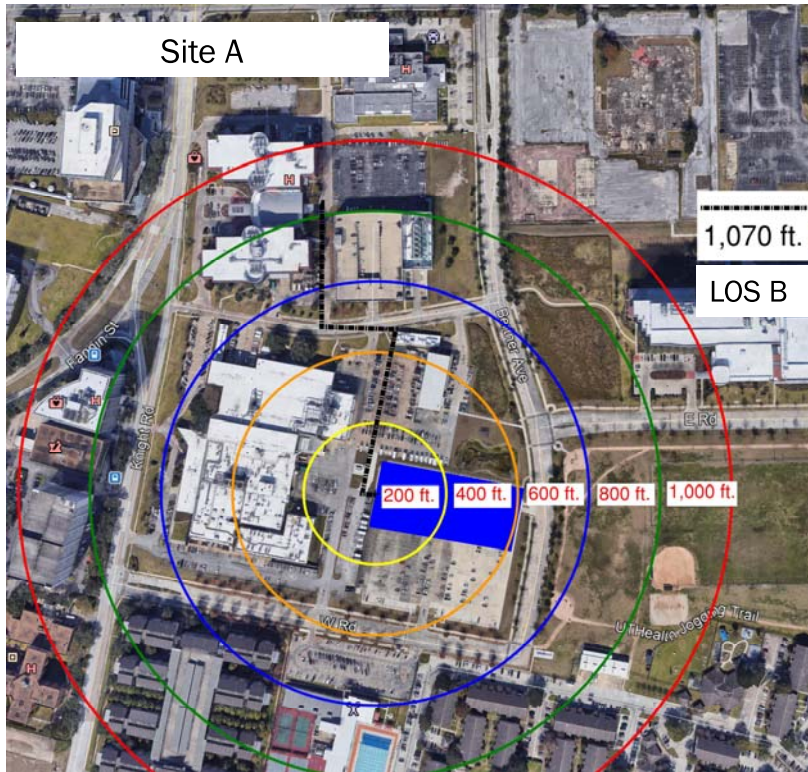

Appendix H
South Campus Master Framework

Traffic Study



Existing Conditions

The MD Anderson Campus property is bounded by the following streets:

- Old Spanish Trail (OST) on the north
- West Road on the south
- Fannin Street/Knight Road on the west
- Cambridge Street on the east

According to the City of Houston (COH) 2018 Major Thoroughfare Plan (MTFP), OST and Fannin are designated as a Major Thoroughfare, Cambridge is designated as a Major Collector and Knight is designated as a Transit Corridor Street, as seen in Figure 1.

The COH GIMs records historical counts at some locations within the city ROW, there are Average Daily Traffic (ADT) locations along Fannin, OST and Cambridge. Some recent ADTs on the adjacent roadways are listed below:

- OST – 33,161 ADT in 2018
- Cambridge – 9,324 in 2020
- Fannin – 19,794 in 2015

The adjacent roadways do not appear on the COH's Capital Improvement Plan (CIP) for improvements and Walter P Moore found no studies for planned improvements within this area. However, there are various planned developments in the Texas Medical Center (TMC) area.

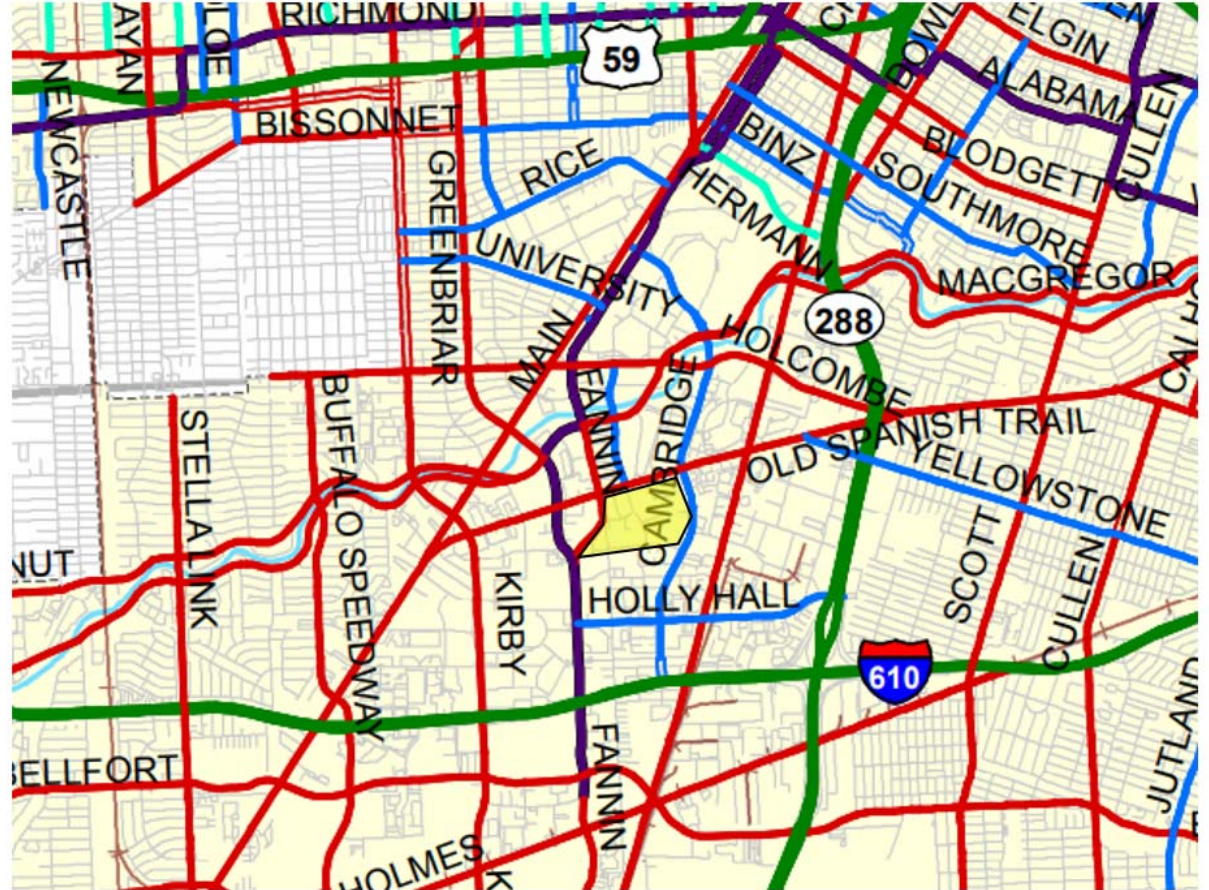

Figure 1. Major Thoroughfare and Freeway Map

Existing Conditions

2. Analyze – Existing Conditions

The site is near existing public bicycle facilities. According to the 2019 Houston Bicycle Master Plan and as seen in Figure 2, OST, Bertner, Cambridge are existing dedicated in street bikeway.

Public transportation within the Texas Medical Center (TMC) primarily consists of the Metropolitan Transit Authority of Harris County (METRO), which operates local bus routes, park and ride routes, and light rail throughout the area. Fort Bend County Public Transportation and the Woodlands Express operated through the Brazos Transit District also provide a Park and Ride service throughout the morning and evening peak periods. The Texas Medical Center and member institutions also provide shuttle services for employees, patients and visitors throughout their buildings and parking facilities.

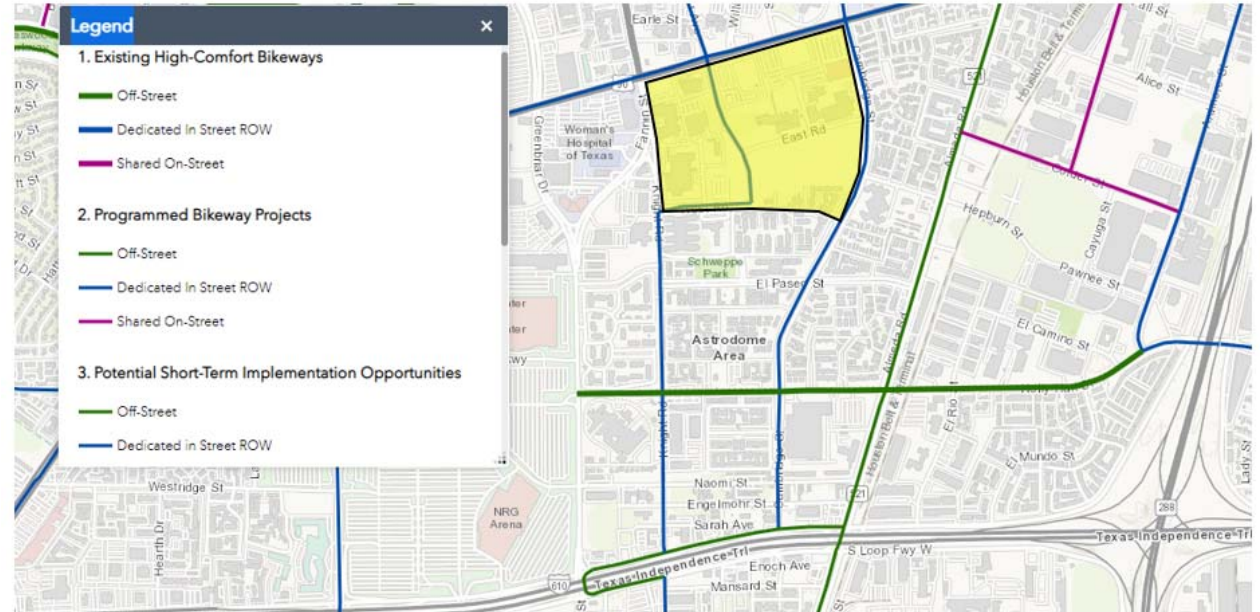

Figure 2. 2019 Houston Bicycle Master Plan

Existing Conditions

The following projects have been approved by the COH and are expected to be built and operational before the MD Anderson development buildout:

CHI St. Luke's McNair Campus is located on Old Spanish Trail west of Cambridge. CHI is to the east of the MD Anderson site and will include 750 additional hospital beds and 450,000 SF of medical-dental office to be open by 2021. The following proposed mitigation measures found in the CHI TIA:

Old Spanish Trail and Robertson Road/Staffordshire (minor street stop-controlled)

- Install a new traffic signal (design has been approved by COH and TxDOT)
- Construct a westbound right-turn bay (150-foot storage) on Old Spanish Trail (design has been approved by TxDOT)
- Provide overlap phasing for westbound right-turn and southbound right-turn
- Coordinate the new signal with Old Spanish Trail and Cambridge Street intersection

Cambridge Street and Butler Boulevard (signalized)

- Construct an eastbound right-turn lane (100-foot storage) on Butler Boulevard and restripe the approach to right only and double left-turns
- Construct a southbound right-turn lane (150-foot storage) on Cambridge Street onto Butler Boulevard
- Provide overlap phasing for eastbound right-turn (Butler Boulevard to Cambridge Street) and southbound right-turn (Cambridge Street to Butler Boulevard)

Cambridge Street and Wyndale Street (minor street stop-controlled)

- Install pavement markings to provide eastbound right turn only and left turn only lanes (100-foot storage)

Cambridge Street and Holcombe Boulevard (signalized)

- At the full build-out, the level of service declines to E or worse and can be mitigated with the construction of an additional northbound left-turn on Cambridge Street or additional through lanes on Holcombe Boulevard. ROW is not available for any additional improvements

Braeswood Boulevard and Wyndale Street (minor street stop-controlled)

- Restripe the Wyndale Street approach to provide westbound right only and left only turn lanes (100-foot storage)
- Restrict parking along the north curb for 250 feet

HMH Braeswood Garage and Office is located along Braeswood west of Greenbriar which is northwest of the MD Anderson site. HMH will include 180,000 SF of medical-dental office and a 1,000-parking garage to be open by 2022. The following proposed mitigation measures found in the HMH TIA:

Main Street at Greenbriar Drive

- Convert the protected left-turn movements to flashing yellow arrow (FYA) protected / permitted movements.

Site Driveway B at Braeswood Drive

- Construct a left-turn bay is proposed (70-foot storage) for the eastbound to northbound movement

7200 Main Mix-Use Development is located along Main north of Greenbriar which is northwest of the MD Anderson site. 7200 Main will include 800 units of mid-rise residential, 425 hotel rooms, 400,000 SF office, 40,000 SF of restaurants and 65,000 SF of retail space to be open by 2022. The following proposed mitigation measures found in the 7200 Main TIA:

Main Street at Pressler Street

- Convert the protected left-turn movements to flashing yellow arrow (FYA) protected / permitted movements

Main Street at Glen Haven Boulevard

- Design the access initially as a right-in / right-out with the ability to convert it to a signal in the future.

TMC⁹ is located directly north of the MD Anderson campus between Bertner, Cambridge and Wyndale. The proposed campus consists of research and development buildings for various institutions of the Texas Medical Center as well as hotel, office and residential space. The proposed campus will be implemented in two phases:

- Phase 1 is anticipated to open in year 2022 and will include the construction of the street network within the site along with two research development buildings (Parcels C and D) with retail space on the first floor (total of 860,000 SF and 34,356 SF, respectively) with 691 underground (Parcels C and D) and 1,888 above parking spaces (Parcel I).
- Phase 2 in anticipated to open in year 2027 and will include the construction of the remainder research and development buildings (Parcels A, B, E, F, J/K) with retail space on the first floor (total of 1,350,000 SF and 78,755 SF, respectively) with 1,250 underground parking spaces and a development by others that includes hotel (400 rooms), office (500,000 SF), high-rise residential (350 units).

Implementation

Another item that the COH and TxDOT will review is driveways to loading dock/wells/berths. AutoTURN drawings can be developed using the expected truck size in the loading dock. The following standard criteria is important to consider:

Loading docks/wells/berths are not permitted for back-in loading from an adjacent Major Thoroughfare.

Loading docks/wells/berths must be located on site to provide for approach and maneuvering on-site with appropriate space to accommodate dimensions of vehicles accessing site.

Loading docks/wells/berths must be located on site such that sufficient area is available to store commercial motor vehicle, truck-tractor, trailer, or semi-trailer or combination of such vehicles within the developed property and no part of vehicle shall protrude over the property line or obstruct any public street or sidewalk in whole or in part.

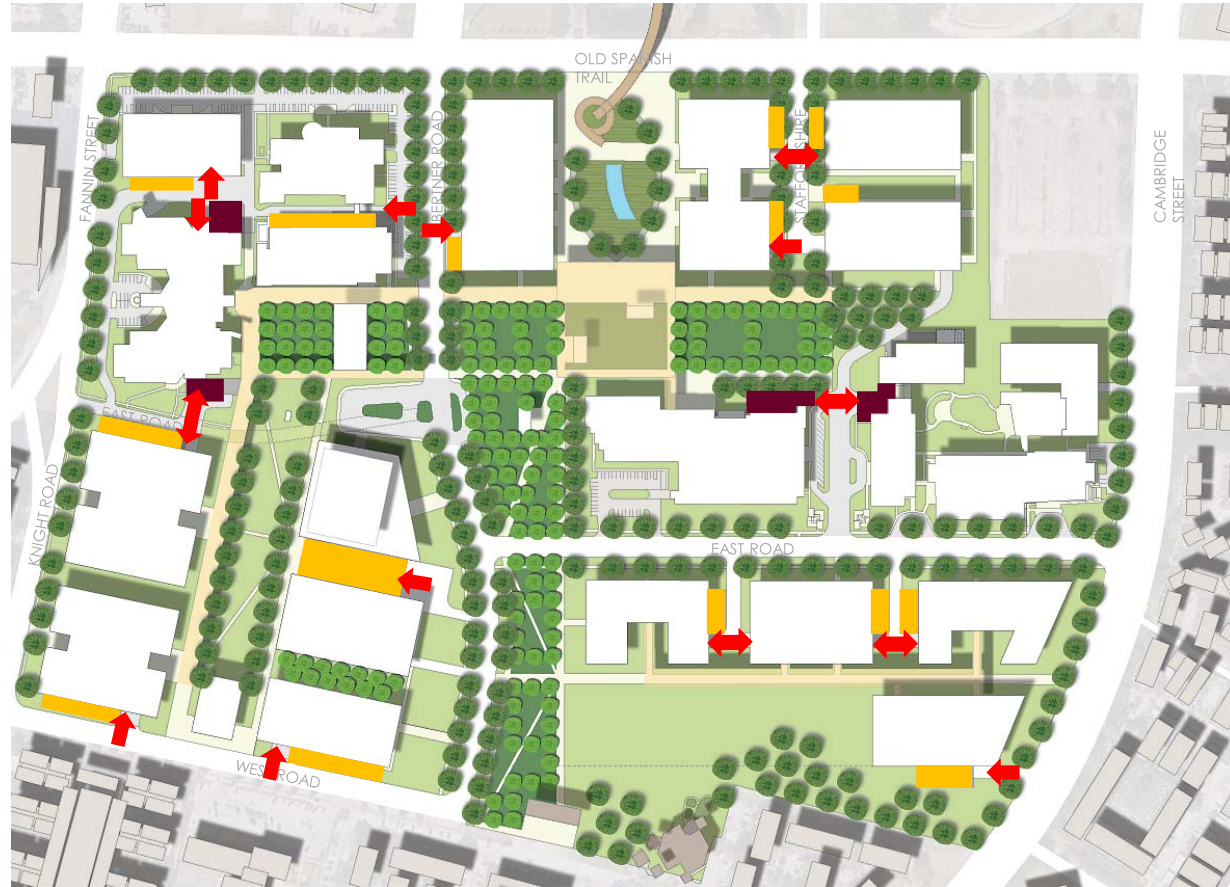

Figure 6. Dock and Service Zones

Implementation

Internal roadways within the Fannin/Kinght, Old Spanish Trail, Cambridge and West site boundary will remain as private roadways.

However, the site is located within the City of Houston and adjacent to COH owned roadways such as Cambridge, Fannin, Knight as well as adjacent to TxDOT owned roadway such as OST; therefore, any development would be required to meet criteria presented in the City of Houston's latest Infrastructure Design Manual (IDM) adopted July 2020 and TxDOT's Access Management Manual and Roadway Design Manual.

COH requires that for each proposed development or redevelopment, an Access Management Data Summary Form must be submitted. Access Management Form provides general property information, an initial estimate of traffic volumes associated with the property and a site plan showing any proposed driveways meeting COH Chapter 15 design criteria standards for distance to an intersection as well as width and curb radius. The site falls under a commercial type development, which driveway criteria is summarized in Figures 3 and 4 from the COH IDM:

Other COH general driveway design criteria includes:

A driveway shall not connect to a sub-standard street. This will not apply to removal and replacement of single-family residential driveways.

- A shared driveway cannot connect to a street with a width of less than 18-feet

- One-way driveways must intersect city streets between 45 and 90 degrees.
- Skewed, one-way drives are permitted only on one-way streets and divided streets with no median opening.
- Two-way driveways must intersect city streets at approximately 90 degrees.
- Where situations permit, AASHTO design vehicles may be used to justify driveway radii.
- No driveway radius shall encroach on abutting property or corner radius.
- Driveways shall not be permitted within limits of any intersection. (Design exception shall be required for major thoroughfare locations with existing esplanades and streets used for residential access.)
- For one-way driveways, the entry driveway shall precede exit driveways (in direction of adjacent travel lane).
- Driveway must remain tangential for a minimum of 20 feet past the property line.
- Where present or projected traffic operations indicate needs for alternative driveway geometrics, additional consideration may be given.

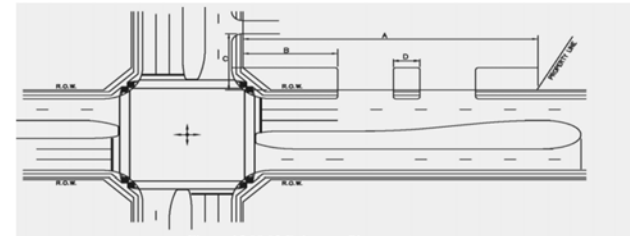

Figure 15.08.03 Driveway Placement

A Frontage (2)	Number of Driveways	B Minimum Driveway Offset (Primary Street)	C Minimum Driveway Offset (Intersecting Street)	D Minimum Driveway Spacing
Up to 170 feet	1	100 feet	60 feet	20 feet
170 to 250 feet	2	100 feet	60 feet	40 feet
250 to 450 feet	3	100 feet	60 feet	40 feet
> 450 feet	1 additional / 250' frontage	100 feet	60 feet	40 feet

(1) Applicable to driveways designed for commercial traffic (auto, truck, and bus access).
 (2) Where the development frontage is equal to or greater than the distance to first median opening, at least one driveway will be aligned with the existing and/or future location of the median opening.
 (3) For CBD or Locations unable to comply, approval of the City Engineer required.
 (4) All proposed access connections must be placed to achieve adequate intersection sight distance for safe and efficient departure from the proposed access connection (comply with AASHTO standard).
 (5) The minimum driveway offset for all major thoroughfare shall be 100 feet.
 (6) Driveway radius cannot extend beyond property line.
 (7) Driveway radius cannot extend into public street or other driveway curb radius.
 (8) Minimum offset will be 100' along bus routes.

Figure 3. Driveway Placement Criteria (Source: COH IDM Ch 15)

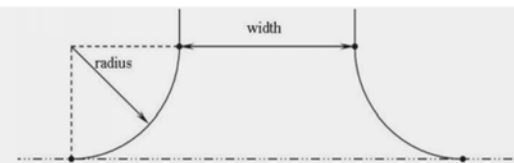

Figure 15.08.01 Driveway Radius and Width

	Single Family Residential		Townhomes / Condos				Commercial					
	Radius (ft)		Radius (ft)		Radius (ft)		Radius (ft)		Radius (ft)			
	Max	Min	Max	Min	Max	Min	Max	Min	Max	Min		
Two-way or Shared Access	10	4	24	12	10	4	24	18	20	10	35	24
One-Way	10	4	20	12	10	4	24	15	20	10	20	15

Figure 4. Driveway Radius and Width (Source: COH IDM Ch 15)

Implementation

TxDOT requires for sites to follow driveway criteria is summarized in Figure 5 from the TxDOT's Access Management Manual:

Other TxDOT general driveway design criteria relative to this site includes:

All parts of entrances and exits on highway right of way, including the radii, shall be confined within the permittee's property frontage. Frontage is that portion of the right of way lying between two most distant possible lines drawn perpendicularly from the centerline of the highway to the permittee's abutting property line.

When the permittees of two or more adjoining properties agree to combine their property frontage for a shared access driveway, the combination would be encouraged and authorized under the applicable regulations. The frontage will then be the portion of the right of way lying between the two most distant possible lines of the combined frontage drawn perpendicularly from the centerline of the highway to the permittees' abutting property lines.

The angle of the driveway from the highway pavement shall be 75 to 90 degrees, except that one-way 45 to 90 degree angle driveways will be permitted for connections to one-way frontage roads or lane divided highways.

All driveway construction shall comply with the Americans with Disabilities Act Accessibility Guidelines and Texas Accessibility Standards requirements and standards. The applicant shall provide appropriate access as determined by TxDOT regardless of the presence of adjacent sidewalks.

The width of a commercial driveway and the radius of curvature connecting the driveway to high-way pavement may vary in size depending on traffic and location and should be selected in accordance with Appendix C of the Roadway Design Manual.

Table 2-2: Other State Highways Connection Spacing Criteria

Other State Highways Minimum Connection Spacing ⁽¹⁾⁽²⁾⁽³⁾	
Posted Speed (mph)	Distance (ft)
≤ 30	200
35	250
40	305
45	360
≥ 50	425

(1) Distances are for passenger cars on level grade. These distances may be adjusted for downgrades and/or significant truck traffic. Where present or projected traffic operations indicate specific needs, consideration may be given to intersection sight distance and operational gap acceptance measurement adjustments.

(2) When these values are not attainable, refer to the variance process as described in Chapter 2, Section 5.

(3) Access spacing values shown in this table do not apply to rural highways outside of metropolitan planning organization boundaries where there is little, if any, potential for development with current ADT levels below 2000. Access connection spacing below the values shown in this table may be approved based on safety and operational considerations as determined by TxDOT.

Figure 5. Driveway Spacing Criteria (Source: TxDOT's Access Management Manual)

Implementation

In addition to filing the Access Management Form, a Traffic Impact Analysis (TIA) may be required by City of Houston and TxDOT.

If the proposed development or redevelopment generates 100 or more new peak hour trips (PHT), the Analysis Engineer should meet with the City to determine the requirement for a Traffic Impact Study.

If after discussion with the City, a Traffic Impact Study is required, the extent of the area to be studied will be determined.

If an applicant submits a development plat application or building permit application for new development or redevelopment, the applicant may voluntarily submit a TIA to support the trip generation rates and access management needs to the adjacent street system for the proposed project.

The City may ask for a technical memorandum in lieu of a full Traffic Impact Analysis (TIA). The technical memo shall be submitted when the proposed development generates 80 vph -120 vph during AM or PM peak hours, utilizing the trip generation rates in the latest edition of the Traffic Generation Manual. The technical memo shall address the immediate intersection(s) to the proposed development.

As shown in the table, the proposed MD Anderson development will generate more than 100 PHT in each programed phase **requiring a TIA**.

A TIA approval is needed in order to receive approval of replats or building permits. Guidelines for the preparation of a TIA are contained in Chapter 15 of the COH Infrastructure Design Manual. Review and approval of a TIA for the COH can be a long process and it may vary depending on the possible mitigation measures presented in the TIA. It is not unusual for this process to require 4-6 months, and in some cases this approval could take 9 months. In accordance with the requirements of the COH, developers are required to mitigate traffic impacts by making mobility improvements in the area to the extent that is possible. Some possible mitigation measures to this particular site could include:

- Upgrades and modifications to the OST at Robertson/Staffordshire traffic signal
- Upgrades and modifications to the OST at Bertner traffic signal
- Upgrades and modifications to the OST at Fannin traffic signal timings
- Upgrades and modifications to the OST at Cambridge traffic signal

It is also important to note that a TIA can only be performed during 'normal' traffic flow periods. Therefore, traffic counts at multiple locations must be collected when school is in session and cannot be taken around major holidays or events in the area.

The current MD Anderson planned development will roughly generate the following peak hour trips (PHT):

ITE Code	Building Name	Trip Generation Land Use	Size	Unit	Weekday	A.M. Peak	P.M. Peak
					Total	Total	Total
760	SCRUB 5 (MDA)	R&D	600,000	SF	6,756	252	294
760	Vivarium (MDA)	R&D	450,000	SF	5,067	189	221
760	School of Health Education (MDA)	R&D	300,000	SF	3,378	126	147
760	UT Health (UT)	R&D	300,000	SF	3,378	126	147
TOTAL 5-7 YEAR PLAN					18,579	693	809
760	Research 1 (MDA)	R&D	330,000	SF	3,716	139	162
760	UT Research 1 (UT)	R&D	300,000	SF	3,378	126	147
760	UT Research 2 (UT)	R&D	300,000	SF	3,378	126	147
TOTAL 15 YEAR PLAN					10,472	391	456
760	Research 2 (MDA)	R&D	570,000	SF	6,418	239	279
760	Research 3 (MDA)	R&D	360,000	SF	4,054	151	176
760	MDA OST (MDA)	R&D	360,000	SF	4,054	151	176
760	UT Research 2 (UT)	R&D	300,000	SF	3,378	126	147
TOTAL 30 YEAR PLAN					17,904	667	778
TOTAL					46,955	1,751	2,043

Data from Trip Generation 10th edition

NOTES

- 1 Trip gen does not include any reductions for transit, walk/bike, internal trips
- 2 Trip gen does not include removal of existing buildings that are not remaining in future years
- 3 Trip gen based on architectural plans dated 02-10-2021

Appendix H
South Campus Master Framework

Mechanical Study



Mechanical Overview

This masterplan provides a framework for the future buildings planned for the South Campus. The South Campus in this report covers all the UT MD Anderson (MD Anderson) and UTHealth owned properties bound by Old Spanish Trail, Cambridge Street, West Road, and Knight Road. The utility load assumptions are based on existing facilities and assume that all buildings meet or exceed the standards and criteria listed below:

- MD Anderson Cancer Center Owner Design Guidelines
- International Mechanical Code
- ASHRAE Data Books for design standards.
- National Fire Protection Association Standards. (NFPA 13,14,20,96 and 101)
- ASHRAE / ASHE Standard 170 - Ventilation of Health Care Facilities (latest edition)
- Texas State Energy Conservation Office (SECO) requirements for state-funded buildings.
- ANSI/ASHRAE Standard 188-2015 Legionellosis: Risk Management for Building Water Systems
- ASHRAE latest edition guidelines
- SMACNA standards 1995 editions
- Applicable ANSI and ASME codes and standards

All of the buildings on this site are located in Houston, Texas and will be designed to ASHRAE climate zone 2A. The following tables show the climatic conditions used for building load calculations and comfort calculations as specified in the current MD Anderson guidelines and ASHRAE weather data.

CLIMATIC DESIGN CONDITION – HOUSTON, TX	
Summer Design (Deg ° F DB/WB) (MD Anderson Guidelines)	96 ° F/80 ° F
Winter Design (Deg ° F)(ASHRAE 99.6% heating DB)	24.8 ° F

Table 1: Climatic Design Conditions

For the research and vivarium buildings, the portions of the buildings that are expected to be laboratory and vivarium spaces will meet a minimum air change rate (ACH). The table below lists the assumed design minimum ACH for each space type:

SPACE TYPE	
Laboratory Space	6 ACH
Vivarium Spaces	12 ACH

Table 2: Minimum Air Change Rates (ACH)

Mechanical Requirements

Existing Mechanical Utilities

The following existing south campus buildings are owned by MD Anderson and are serviced with chilled water and heating hot water from the on-site generation in multiple locations including the central plant attached to the parking garage east of SCRB 1:

- SCRB 1
- SCRB 2
- SCRB 3
- SCRB 4
- Proton Therapy 2
- Smith Research Building
- Physical Plant Building (PPB)

These plans include a plan to re-serve these buildings with TECO chilled water as the existing equipment reaches the end of its useful life. As existing chillers reach the end of their useful life, they will be replaced with plate and frame heat exchangers that receive primary chilled water from TECO. This will allow the existing chilled water distribution piping to remain and be reused to continue to serve these buildings.

Heating Water Systems

All future buildings will have on-site heating hot water generation. Natural gas fired condensing water boilers will be provided at each site to generate heating hot water.

Multiple modular boilers each sized at less than 2,000,000 btu/hr input will be provided to reach a minimum N+1 level of redundancy for each building. This size limitation is to meet the prescriptive requirements of the Texas Commission on Environmental Quality (TCEQ) regulations. Refer to the MEP utility matrix for the projected loads for each individual building.

Chilled Water Systems

The long-term plan for this campus is to consolidate the chilled water generation to be provided by the Thermal Energy Corporation (TECO). TECO has a long history in the Texas Medical Center (TMC) of providing reliable chilled water services to hospital and research facilities. TECO owns and maintains a separate chilled water and steam utility distribution system throughout the TMC and surrounding areas.

MD Anderson has multiple facilities that are currently served by TECO chilled water and steam. For this campus MD Anderson has decided to proceed with only contracting the chilled water to be provided by TECO.

MD Anderson standards require a secondary chilled water system that is decoupled from any 3rd party chilled water systems. Chilled water systems within each building shall be decoupled from the TECO chilled water loop. This will be achieved with plate and frame heat exchangers where the primary side has TECO chilled water and the secondary side has the building chilled water. This creates a clear line of responsibility in water treatment and equipment maintenance.

TECO will provide underground chilled water piping from their central plant to the south campus. TECO will be responsible for the installation and extension of the chilled water distribution up to and inside of each building's mechanical room (for new buildings). TECO will extend 42-inch chilled water supply and return piping north of Old Spanish Trail below Bertner avenue to the south campus. The TECO chilled water distribution is expected to be installed in phases as buildings are constructed.

As existing on-campus chillers reach the end of their useful life chilled water generation capacity will be transitioned to TECO chilled water distribution piping. Chillers will be removed and replaced with plate and frame heat exchangers and pumps. Based on existing central plant equipment ages, this replacement of chillers is shown as part of the 15-year plan phase of the masterplan.

5 Year Plan

This is first major addition to the campus since SCRB 3 and 4 were constructed. In this phase, TECO will extend their chilled water distribution piping across Old Spanish Trail in utility right of ways below Bertner Avenue. Per discussions with TECO, they intend to extend a 42-inch chilled water supply and return line to the South Campus. Initially this line will be extended to serve the SCRB 5 laboratory building and the new Vivarium building. The TECO mains will be located in a utility easement located below Bertner Avenue with the following branch taps in this phase:

- 18-inch taps to SCRB 5
- 12-inch taps to MD Anderson Health Education
- 30-inch taps with valves and caps for future connection to the existing south campus central plant
- 18-inch taps to the Vivarium building

The taps to SCRB 5, the Vivarium, and the MD Anderson School of Health Education shall each be sized for their individual loads with heat exchangers located within each respective building. A mechanical room shall be located in each building to house the required heat exchangers, primary chilled water pumps, and secondary chilled water pumps.

TECO chilled water taps to the existing central plant will be extended from the Bertner Avenue lines and terminate in a valve box for future connection. These taps will be sized to replace all the existing chilled water generation at the south campus central plant plus the addition of the Proton Therapy Building (PTC) 3. The buildings served by the existing plant will continue to use the existing distribution piping when the central plant generation source is completely transitioned to TECO will be as follows:

- SCRB 1 and 2
- SCRB 3 and 4
- PTC 2
- Smith Research Building

New radiation vaults are proposed to be added to the existing south campus SCRB-3 building on the southwest corner of the structure. The following is the mechanical impact of this proposed addition:

Based on SSA understanding of the installed capacities for the chilled water system there is adequate additional capacity to add the expected load for the proposed vaults. New connections to the chilled water system for new air handling units and process chilled water heat exchangers will be

required. Design team to confirm system sizing with owner during design phase. Two new process chilled water heat exchangers and pumps will be needed. Heat exchangers and pumps should be fully redundant and sized without any diversity to serve all of the new equipment within these vaults. Based on SSA understanding of the installed capacities for the heating water system there is adequate additional capacity to add the expected heating and reheat loads for the proposed vault area. New connections to the heating water system for new air handling units and terminal unit re-heat coils will be required. Design team to confirm system sizing with owner during design phase. New air handling units will be required to serve the entire building addition and should be connected to the existing chilled and heating water systems within the existing building.

For the new UTHealth Education building, underground chilled water piping will be routed from the existing UTHealth central plant on the east side of the site to the new building. Based on the current building load projections, the existing plant will have adequate existing capacity to serve this new load and maintain N+1 redundancy. This piping will be upsized to the street with a 20-inch tap to allow for a future back-feed from TECO. Further information on this will be described in the 15-year plan.





Utility Demand Matrix

See below for the utility demand matrix for all of the proposed buildings:

SOUTH CAMPUS BUILDING UTILITY DEMANDS											
5-7 Year Plan											
BUILDING NAME	BUILDING SQ. FT.	CHILLED WTR (TONS)	CHILLED WTR (GPM)	HEATING WTR (MMBTU)	DOM. WATER (GPM)	FIRE WATER (GPM)	NATURAL GAS (CFH)	POWER (NORMAL) (KW)	POWER (EMERG) (KW)	SANITARY (GPM)	STORM (GPM)
MDACC SCRB5	600,000	3,250	4875	24	450	1500	31,000	2400	900	440	8000
MDACC Vivarium	450,000	3,600	5400	26	450	1500	28,000	2250	2250	440	5200
MDACC Health Education	300,000	1,100	1650	8	275	1500	15,400	1200	450	360	3000
MDACC Parking Garage	360,000	N/A	N/A	N/A	100	1875	N/A	144	144	100	8400
UT Health Education	300,000	1,100	1650	8	275	1500	15,400	1200	450	360	3000
15 Year Plan											
BUILDING NAME	BUILDING SQ. FT.	CHILLED WTR (TONS)	CHILLED WTR (GPM)	HEATING WTR (MMBTU)	DOM. WATER (GPM)	FIRE WATER (GPM)	NATURAL GAS (CFH)	POWER (NORMAL) (KW)	POWER (EMERG) (KW)	SANITARY (GPM)	STORM (GPM)
UT Parking Garage		N/A	N/A	N/A				144	144		
MDACC Parking Garage	360,000	N/A	N/A	N/A	N/A	1875	N/A	144	144	N/A	8400
MDACC Central Plant		N/A	N/A	N/A	150	N/A	N/A	N/A	N/A	150	N/A
MDACC Research 1	330,000	2,000	3000	15	275	1500	15,400	1320	600	360	4600
MDACC Proton Therapy					200	1000	2000	N/A	N/A	180	1500
UT Health Research 1	300,000	1,600	2400	14	275	1500	15,400	1200	600	360	3000
UT Health Research 2	300,000	1,600	2400	14	275	1500	15,400	1200	600	360	3000
30 Year Plan											
BUILDING NAME	BUILDING SQ. FT.	CHILLED WTR (TONS)	CHILLED WTR (GPM)	HEATING WTR (MMBTU)	DOM. WATER (GPM)	FIRE WATER (GPM)	NATURAL GAS (CFH)	POWER (NORMAL) (KW)	POWER (EMERG) (KW)	SANITARY (GPM)	STORM (GPM)
MDACC Research 2	570,000	2,000	3000	15	350	1500	30,000	2280	1140	440	8000
MDACC Research 3	360,000	2,000	3000	15	300	1500	18,000	1440	720	360	5000
MDACC MDA (OST)	360,000	1,950	2925	15	300	1500	18,000	1440	540	360	3800
UT Health Research 3	300,000	2,000	3000	14	275	1500	15,400	1200	600	360	3000

5 Year Plan

LEGEND

TYPE	SYMBOL
New TECO Piping	
New MD Anderson Piping	
New UTHealth Piping	
Piping from Previous Phase	

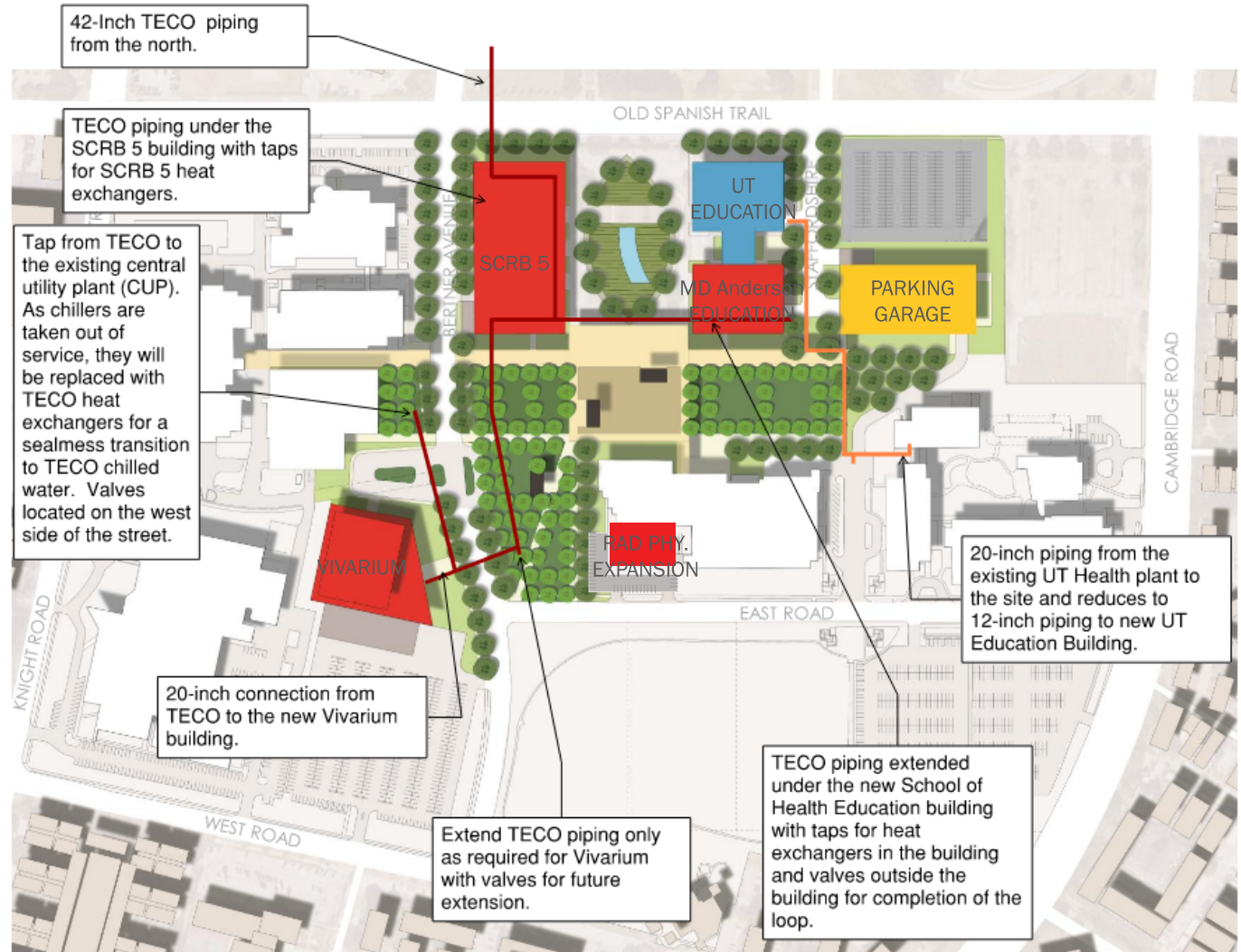

15 Year Plan

This phase of the project extends the TECO chilled water distribution to the existing MD Anderson central plant, new central plant in the Southwest Garage, and a new UTHealth central plant in the Southeast Garage. Each of these new plants will be hubs to serve buildings in the 15 and 30-year plans.

Each of the 3 connections in this phase are connections to serve multiple buildings.

Existing Central Plant

The TECO extension to the existing central plant will be extended from the valve vault installed in the 5-year plan to the existing central plant. This will be sized for 9,500 tons of firm capacity to serve the following buildings:

- SCRB 1 and 2
- SCRB 3 and 4
- PTC 1, 2, and 3
- Smith Research Building

As the existing chillers reach the end of their useful life, they will be replaced by plate and frame heat exchangers and primary chilled water pumps. Using the existing chiller connections to the chilled water system will allow the utilization of the existing piping distribution to these buildings as well as remove potential outages to tie in the new equipment to the existing piping. Heat exchangers will be sized such that as equipment is replaced N+1 redundancy will be maintained.

Southwest Parking Garage

In the Southwest Parking Garage there will be mechanical space to house primary chilled water pumps, chilled water heat exchangers, and secondary chilled water pumps. This will act as a chilled water decoupling location for the MD Anderson owned buildings on the southwest side of the campus including:

- MD Future Building 1
- MD Future Building 2
- MD Future Building 3
- Shared Resources Building

The equipment shall be designed to maintain N+1 redundancy for this secondary chilled water system. The final buildout capacity of this system is expected to be 6,000 Tons firm capacity. Equipment installed in this phase will only serve the MD Anderson Future Building 1 building with N+1 redundancy. Piping mains and mechanical rooms will be sized for their final estimated capacities. This is expected to require approximately 6,000 sq ft of dedicated mechanical room space within the garage.

Southeast Parking Garage

In the Southeast Parking Garage there will be mechanical space to house primary chilled water pumps, chilled water heat exchangers, and secondary chilled water pumps. This will act as a chilled water decoupling location for the UTHealth owned building on the southeast side of the campus including:

1. UT Future Building 1
2. UT Future Building 2
3. UT Future Building 3





The equipment shall be designed to maintain N+1 redundancy for this secondary chilled water system. The final buildout capacity of this system is expected to be 4,700 Tons firm capacity. Equipment installed in this phase will only serve the UT Research 1 and UT Future 2 buildings with N+1 redundancy. Piping mains and mechanical rooms will be sized for their final estimated capacities. This is expected to require approximately 5,000 sq ft of dedicated mechanical room space within the garage.

UTHealth Existing Plant

UTHealth is evaluating pursuing a similar chilled water equipment strategy that would involve replacing existing chillers as they reach the end of their useful life. This would involve routing TECO chilled water across the new walking paths to the north of SCRB 3 and 4 to the existing UTHealth central plant. As chillers are removed from service, they would be replaced with a new primary pump and plate and frame heat exchanger connection to TECO. Similar to the MD Anderson approach, this will allow the re-use of existing piping and a phased approach to removing existing equipment with minimal outages required. The equipment shall be designed to maintain N+1 redundancy for this secondary chilled water system. The final buildout capacity of this system is expected to be 4,500 Tons firm capacity.

15 Year Plan – Phase 1 UTHealth

LEGEND

TYPE	SYMBOL
New TECO Piping	
New MD Anderson Piping	
New UTHealth Piping	
Piping from Previous Phase	

CHWS/CHWR piping to/from PTC 3. Capacity will have to be evaluated at the plant prior to connection. One TECO heat exchanger may be required to gain the additional capacity required.

TECO piping connection to CUP. As existing chillers are taken off-line due to age, new TECO heat exchangers will replace their function.

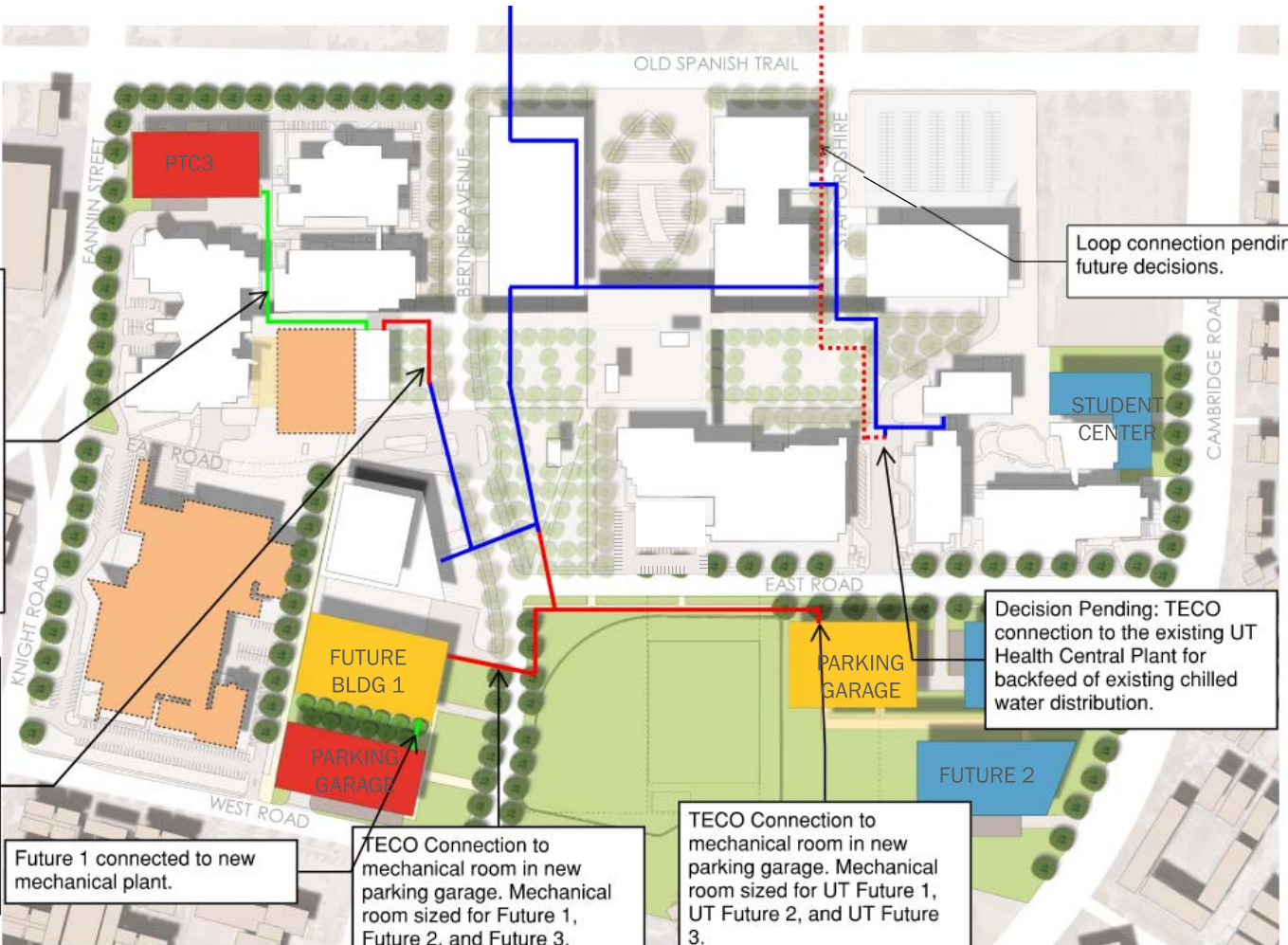

Future 1 connected to new mechanical plant.

TECO Connection to mechanical room in new parking garage. Mechanical room sized for Future 1, Future 2, and Future 3.

TECO Connection to mechanical room in new parking garage. Mechanical room sized for UT Future 1, UT Future 2, and UT Future 3.





Decision Pending: TECO connection to the existing UT Health Central Plant for backfeed of existing chilled water distribution.

Loop connection pending future decisions.

15 Year Plan – Phase 2

4. Visualize – Proposed Future State

LEGEND

TYPE	SYMBOL
New TECO Piping	
New MD Anderson Piping	
New UTHealth Piping	
Piping from Previous Phase	

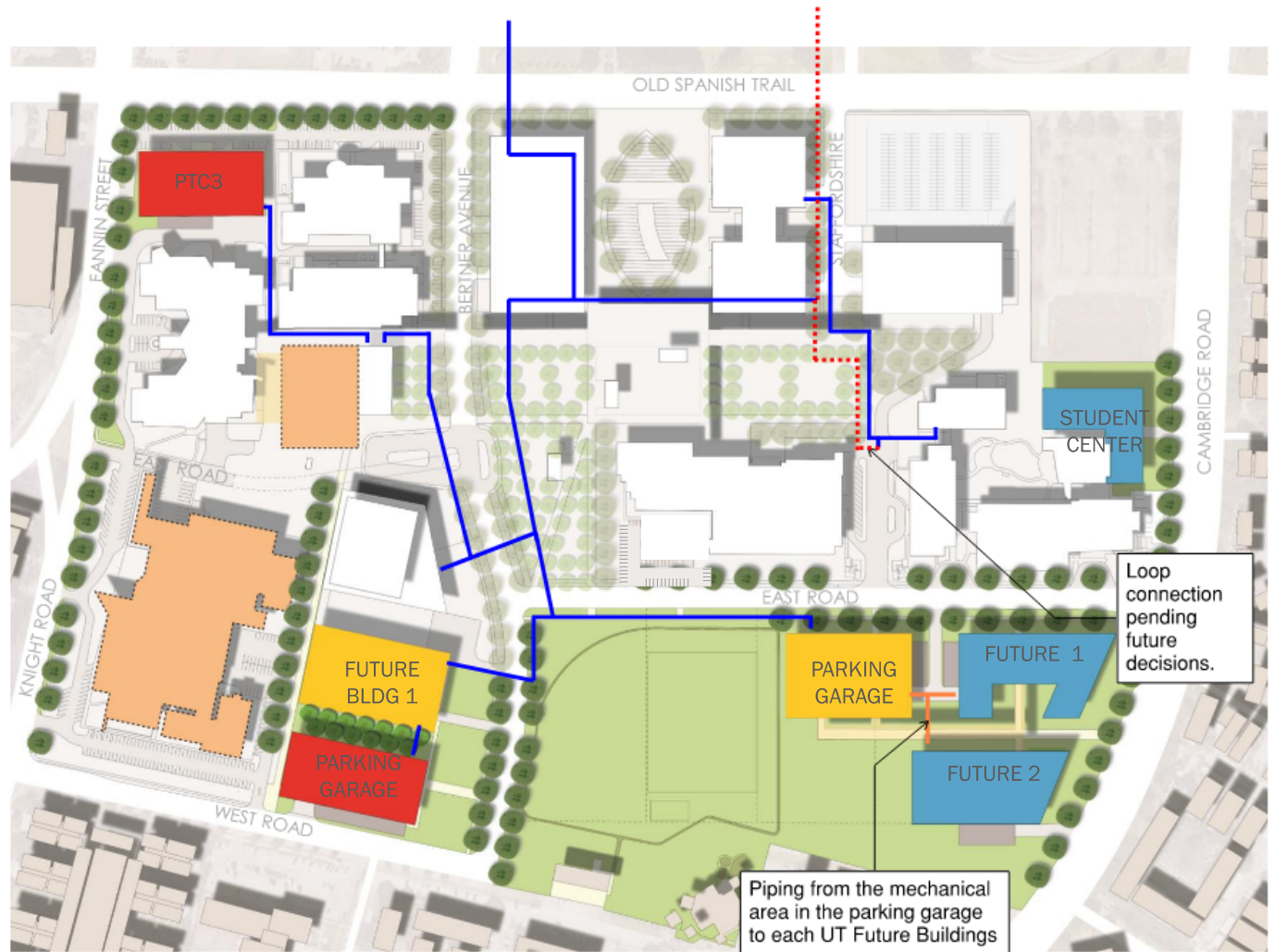

30 Year Plan

This phase of the project extends the secondary chilled water systems from the plants established in the 15-year plan and has one new connection from TECO for the MD Anderson Future Needs Building 4 located on the northeast side of the campus.





The South Parking Garage will have secondary chilled water piping extended to MD Anderson Future Building 2, MD Anderson Future Building 3, and the Shared Resources building. As each building is constructed the required pumps and heat exchangers will be installed in the mechanical space to maintain N+1 redundancy in this system.

The UT Parking Garage will have secondary chilled water piping extended to UT Future 3. As part of the building project the required pumps and heat exchangers will be installed in the mechanical space to maintain N+1 redundancy in this system.

It is anticipated that TECO will extend an additional line south of Old Spanish Trail at the proposed Staffordshire road that TECO may use to complete the chilled water loop on the south campus. This loop is not confirmed but would provide additional dependability to the system by providing multiple potential chilled water paths.

30 Year Plan

LEGEND

TYPE	SYMBOL
New TECO Piping	
New MD Anderson Piping	
New UTHealth Piping	
Piping from Previous Phase	

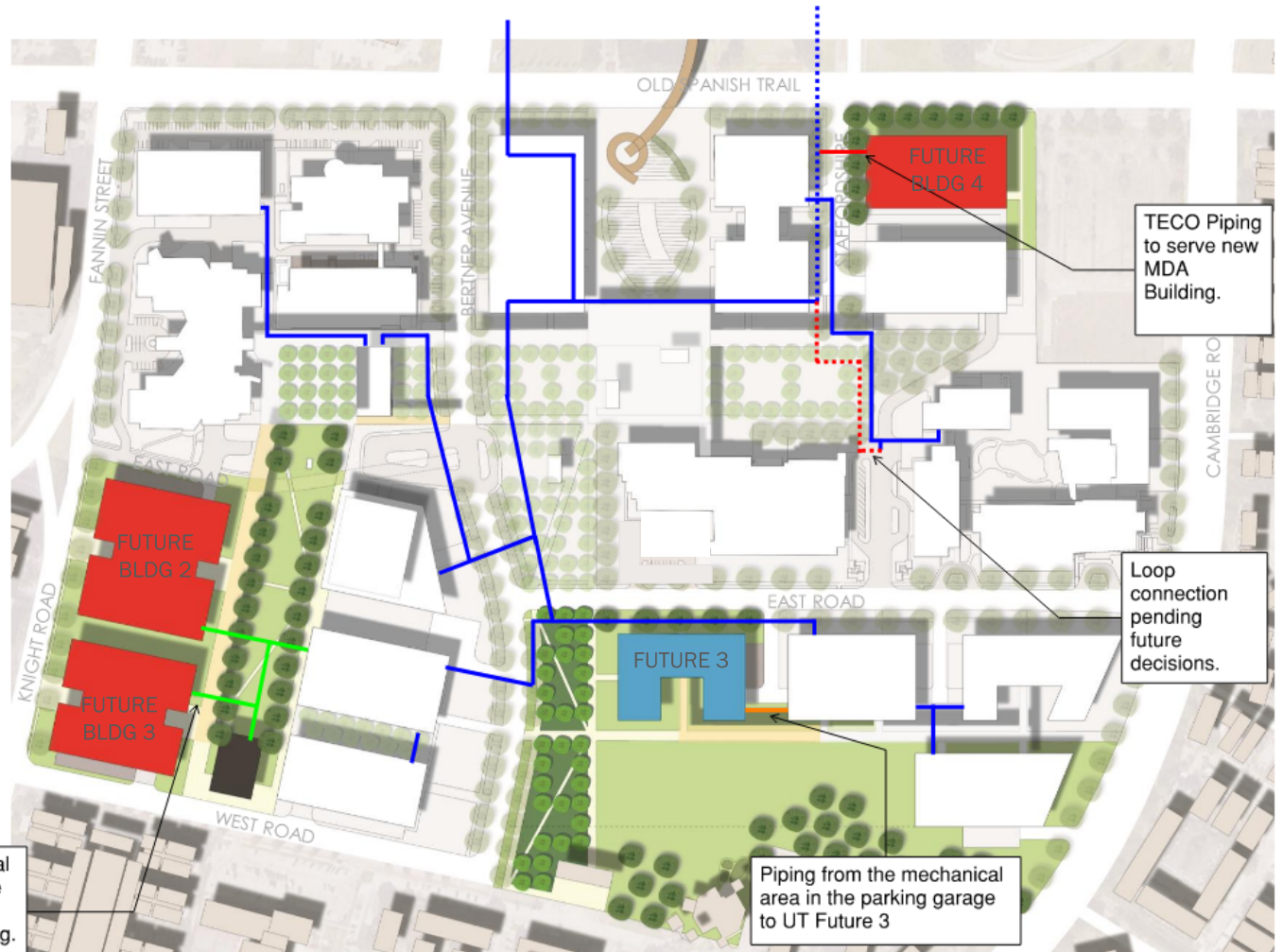

Appendix H
South Campus Master Framework

Electrical Study



Existing Conditions

Overhead CenterPoint Energy (CNP) Lines Along Old Spanish Trail

There are currently three sets of CNP overhead lines that run East/West along Old Spanish Trail. The distribution level overhead lines on the North and South side of Old Spanish Trail (OST) are both served from the Plaza substation. The transmission level line South of OST serves the Plaza substation. Approximately 1400' of these overhead lines will be relocated underground by CNP later to make room for the installation of the planned bridge across OST that will connect the North and South sides of TMC³.

South Campus CNP Feeders

CenterPoint Energy (CNP) has four 34.5kV dedicated circuits that extend underground from the South Campus to the Plaza substation. These circuits serve all MD Anderson and UTHealth buildings on the South campus except for the Smith Research Building (SRB) which is served from the CNP overhead line along Knight Road. CNP has noted the existing underground feeders have the capacity to serve the new South campus loads.

UTHealth Central Plant

Normal Power

The existing UTHealth central plant contains normal and emergency power systems that currently serve the Central Plant, BREF building and Dental school. The normal power service consists of two 5000kVA, 34.5kV-4.16kV, CNP pad mount transformers that serve UTHealth owned 5kV, Main-Tie-Main Metal Clad switchgear located in the plant electrical room. This switchgear serves all central plant, BREF and Dental building loads. The service has capacity to serve the existing loads and the new UTHealth Education building and still maintain N+1 redundancy.

Emergency Power

The existing emergency power service at the central plant consists of two 1250kW diesel generators and one 1500kW diesel generator. All generators are connected via 5kV paralleling switchgear located in the plant emergency electrical room. The paralleling switchgear serves all Central Plant, BREF and Dental building loads. The service has capacity to serve the existing loads and the new UTHealth Education building and still maintain N+1 redundancy.

5 Year Plan

5-7 Year Plan – MD Anderson

MD Anderson Normal Power

East of Bertner – SCRB5 and Education

The MD Anderson SCRB5 and Education buildings located East of Bertner will be served from a CNP service located at the East parking garage. The CNP service will consist of two 34.5kV feeders, two 35kV pad mount auto transfer switches and two 5000kVA, 34.5kV-4.16kV pad mount transformers. The two 34.5kV feeders will originate in a CNP manhole with exact location to be determined. Note that if the available outdoor space at the parking garage does not allow for CNP pad mount equipment and the associated easements, the equipment will be in a vault within the garage per CNP standards. In either scenario, the CNP transformers will serve MD Anderson owned 5kV, 1200A, Main-Tie-Main Metal Clad Switchgear located in the normal power electrical room within the garage. This 5kV switchgear will serve 4.16kV-480V substations located inside the SCRB5 and Education buildings via underground duct bank. Note that the 5kV switchgear will also serve the future MD Anderson building under the 30-year plan as noted elsewhere in this report. See one line diagram sheet E010 for the one-line showing this setup.

East of Bertner – SCRB3 Radiation Vaults

New radiation vaults are proposed to be added to the existing south campus SCRB-3 building on the southwest corner of the structure. The following is the electrical impact of this proposed addition: The present peak demand for 3SCRB is less than 1200kva or about 1444A@480V, 3 Phase. The main service for the building consists of 5000A, 480V, Main-Tie-Main switchgear. The anticipated load for five radiation vaults is approximately 225kVA or 270A@480V, 3 Phase. The existing building load plus the new radiation vault load is well below the size of the main service switchgear in the building. Routing of the existing telecom ductbank system goes around the proposed area where the vaults will be constructed. The emergency ductbank from the building to the central plant is North of the building. There are some minor site circuits in the area of the new vaults.

West of Bertner - Vivarium

The MD Anderson Vivarium building will be served from a CNP service located at the Vivarium. The CNP service will consist of two 34.5kV feeders, two 35kV pad mount auto transfer switches and two 5000kVA, 34.5kV-480V pad mount transformers. The two 34.5kV feeders will originate in an existing CNP manhole located on Bertner. Note that if the available outdoor space at the Vivarium does not allow for CNP pad mount equipment and the associated easements, the equipment will be in a vault within the building per CNP standards. In either scenario, the CNP transformers will serve MD Anderson owned 480V, 4000A, Main-Tie-Main Switchgear located in the normal power electrical room within the Vivarium. Note that the 5kV switchgear will also serve the future MD Anderson building under the 30-year plan as noted elsewhere in this report. See sheet E012 for the one-line showing this setup.

MD Anderson Emergency Power

East of Bertner – SCRB5 and Education

The MD Anderson SCRB5 and Education buildings located East of Bertner will be served from an emergency service located at the East parking garage. The emergency service will consist of three 1300kW, 4.16kV natural gas generators and associated 1200A, 5kV paralleling switchgear. The generators will be located either outside the parking garage if space allows or inside the garage in a separate generator room. The 5kV paralleling switchgear will be in an emergency electrical room inside garage. This 5kV switchgear will serve 4.16kV-480V substations and associated automatic transfer switches located in the SCRB5 and Education buildings via underground duct bank. See sheet E011 for the one-line showing this setup.

West of Bertner - Vivarium

The MD Anderson Vivarium will be served from an emergency service located at the East parking garage. The emergency service will consist of three 1300kW, 480V natural gas generators and associated 5000A, 480V paralleling switchgear. The generators will be located either outside the Vivarium if space allows or inside the Vivarium in a separate generator room. The 480V paralleling switchgear will be in an emergency electrical room inside the Vivarium. Note that the entire Vivarium will be connected to emergency power due to the critical nature of the building. See sheet E013 for the one-line showing this setup.

5 Year Plan

4. Visualize - Proposed Future State

LEGEND

TYPE	SYMBOL
Existing	
New	
New CNP Underground Ductbank 34.5 Kv	
Genset	
CNP Underground Manhole Existing	
CNP Auto Transfer Primary Switch	
CNP XFMR	
Existing CNP Underground Ductbank 34.5 kv	

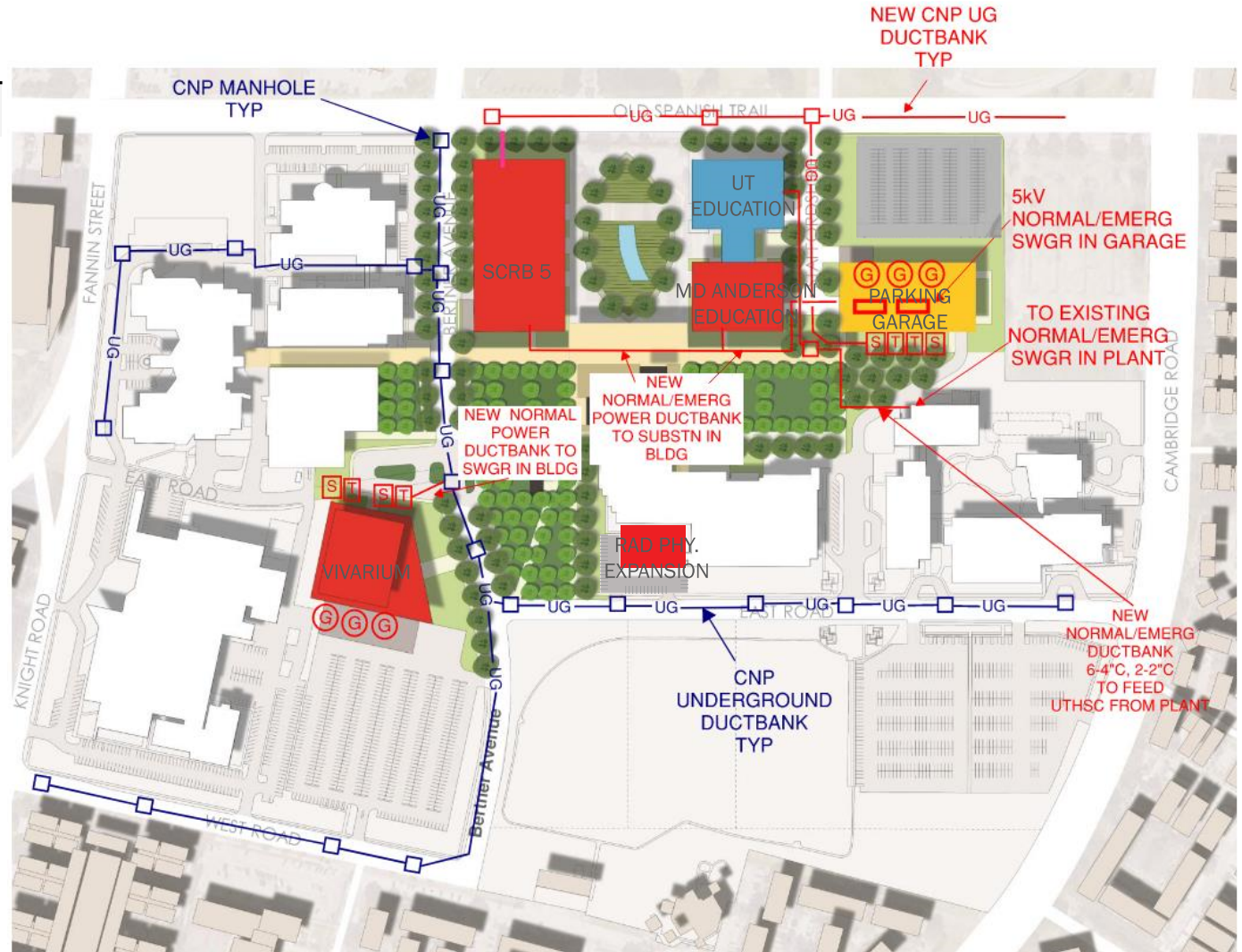

5 Year Plan

5-7 Year Plan – UTHealth Science Center

UTHealth Normal Power

As noted previously, the existing 4.16kV service at the central plant that serves the plant, BREF and Dental buildings has sufficient capacity to serve the new Education building and still maintain N+1 redundancy. The normal power 5kV switchgear has equipped spaces on the A side and B side. New 5kV, 1200A circuit breakers will be installed, one on the A side and one on the B side. A new underground duct bank will be installed between the existing UTHealth central plant and the Education building for the A and B side feeders. The 5kV feeders will serve 4.16kV-480V substations located inside the Education building. See one line diagram on sheet E014.

UTHealth Emergency Power

As noted previously, the existing emergency power service at the central plant consists of two 1250kW and one 1500kW diesel generator that has sufficient capacity to serve the new Education building and still maintain N+1 redundancy. The emergency power switchgear has one equipped space. A new 5kV, 1200A circuit breaker will be installed in this space to serve the new Education building. A new underground duct bank will be installed between the UTHealth plant and the Education building. The 5kV feeder will serve a 4.16kV-480V substation lineup located at the Education building. See one line diagram on sheet E015.

UT CENTRAL PLANT

LOAD	SQ FT	UTILITY DEMAND (W/SQ FT)	EMERGENCY DEMAND (W/SQ FT)	TOTAL UTILITY DEMAND (KW)	TOTAL EMERGENCY DEMAND (KW)
UT EDU	300,000	4	1.5	1200	450

- Total Generating Capacity – 4000kW
- BBS BREF, Central Plant and UT Dental Loads – 1296kW
- Available Emergency Capacity – 2704kW

The table below shows an estimated load analysis for the different buildings that will be constructed as part of the 5-7 Year Master Plan.

UT CENTRAL PLANT

LOAD	SQ FT	UTILITY DEMAND (W/SQ FT)	EMERGENCY DEMAND (W/SQ FT)	TOTAL UTILITY DEMAND (KW)	TOTAL EMERGENCY DEMAND (KW)
SCRB5	600,000	4	1.5	2400	900
VIVARIUM	450,000	5	5	2250	2250
MD ANDERSON HEALTH EDU	300,000	4	1.5	1200	450
MD ANDERSON GARAGE	360,000	0.4	0.4	144	144
UT EDU	300,000	4	1.5	1200	450

15 Year Plan

4. Visualize – Proposed Future State

15 Year Plan – MD Anderson

MD Anderson Normal Power

MD Anderson Research Parking Garage and Future Building 1

The MD Anderson Research Parking Garage and Future Building 1 located West of Bertner will be served from a CNP service located at the parking garage. The CNP service will consist of two 34.5kV feeders, two 35kV pad mount auto transfer switches and two 5000kVA, 34.5kV-4.16kV pad mount transformers. Two additional transformers, one on either side will be added in the future to accommodate MD Anderson Future Needs Building 2 and 3. The two 34.5kV feeders will originate in a CNP manhole on Bertner with exact location to be determined. Note that if the available outdoor space at the parking garage does not allow for CNP pad mount equipment and the associated easements, the equipment will be in a vault within the garage per CNP standards. In either scenario, the CNP transformers will serve MD Anderson owned 5kV, 2000A, Main-Tie-Main Metal Clad Switchgear located in the normal power electrical room within the garage. This 5kV switchgear will serve 4.16kV-480V substations located inside Future Needs Building 1 via underground duct bank. Note that this switchgear will also serve the future MD Anderson Future Needs Building 2 and 3 located West of Bertner. See sheet E016 for the one-line showing this setup.

MD Anderson Emergency Power

MD Anderson Vivarium Parking Garage and Future Needs Building 1

The MD Anderson Vivarium Parking Garage and Future Needs Building 1 located West of Bertner will be served from an emergency service located at the parking garage. The emergency service will consist of four 2000kW, 4.16kV natural gas generators and associated 1200A, 5kV paralleling switchgear. The generators will be located either outside the parking garage if space allows or inside the garage in a separate generator room. The 5kV paralleling switchgear will be in an emergency electrical room inside garage. This 5kV switchgear will serve 4.16kV-480V substations and associated automatic transfer switches located in the Future Needs Building 1 via underground duct bank. The switchgear will also serve central plant substations in the garage. Note that this switchgear will also serve the future MD Anderson Future Buildings 2 and 3 located West of Bertner. See sheet E017 for the one-line showing this setup.

15 Year Plan – UTHealth Science Center

UTHealth Normal Power

UT Parking Garage and UT Future Buildings 1 and 2

The UTHealth Parking Garage and Future Buildings 1 and 2 located East of Bertner and South of East Road will be served from a CNP service located at the parking garage. The CNP service will consist of two 34.5kV feeders, two 35kV pad mount auto transfer switches and two 5000kVA, 34.5kV-4.16kV pad mount transformers. The two 34.5kV feeders will originate in a CNP manhole on East road with exact location to be determined. Note that if the available outdoor space at the parking garage does not allow for CNP pad mount equipment and the associated easements, the equipment will be in a vault within the garage per CNP standards. In either scenario, the CNP transformers will serve UTHealth owned 5kV, 1200A, Main-Tie-Main Metal Clad Switchgear located in the normal power electrical room within the garage. This 5kV switchgear will serve 4.16kV-480V substations located in Future Buildings 1 and 2 via underground duct bank. The switchgear will also serve central plant substations in the garage. Note that this switchgear will also serve the future UT Future Building 3 located East of Bertner. See sheet E018 for the one-line showing this setup.

UTHealth Emergency Power

UT Parking Garage and UT Future Buildings 1 and 2

The UTHealth Parking Garage and Future Buildings 1 and 2 located East of Bertner and South of East Road will be served from an emergency service located at the parking garage. The emergency service will consist of two 2000kW, 4.16kV natural gas generators and associated 1200A, 5kV paralleling switchgear. The generators will be located either outside the parking garage if space allows or inside the garage in a separate generator room. The 5kV paralleling switchgear will be in an emergency electrical room inside the garage. This 5kV switchgear will serve 4.16kV-480V substations and associated automatic transfer switches located in Future Buildings 1 and 2 via underground duct bank. Note that this switchgear will also serve the future UT Future Building 3 located East of Bertner. See sheet E019 for the one-line showing this setup.

The table below shows an estimated load analysis for the different buildings that will be constructed as part of the 15-Year Master Plan.

15-YEAR MASTER PLAN

LOAD	SQ FT	UTILITY DEMAND (W/SQ FT)	EMERGENCY DEMAND (W/SQ FT)	TOTAL UTILITY DEMAND (KW)	TOTAL EMERGENCY DEMAND (KW)
MD ANDERSON RESEARCH GARAGE	360,000	0.4	0.4	144	144
MD ANDERSON RESEARCH 1	330,000	4	2	1320	660
UTHEALTH RESEARCH 1	300,000	4	2	1200	600
UTHEALTH RESEARCH 2	300,000	4	2	1200	600

15 Year Plan

4. Visualize - Proposed Future State

LEGEND

TYPE	SYMBOL
Existing	
New	
New CNP Underground Ductbank 34.5 Kv	
Genset	
CNP Underground Manhole Existing	
CNP Auto Transfer Primary Switch	
CNP XFMR	
Existing CNP Underground Ductbank 34.5 kv	

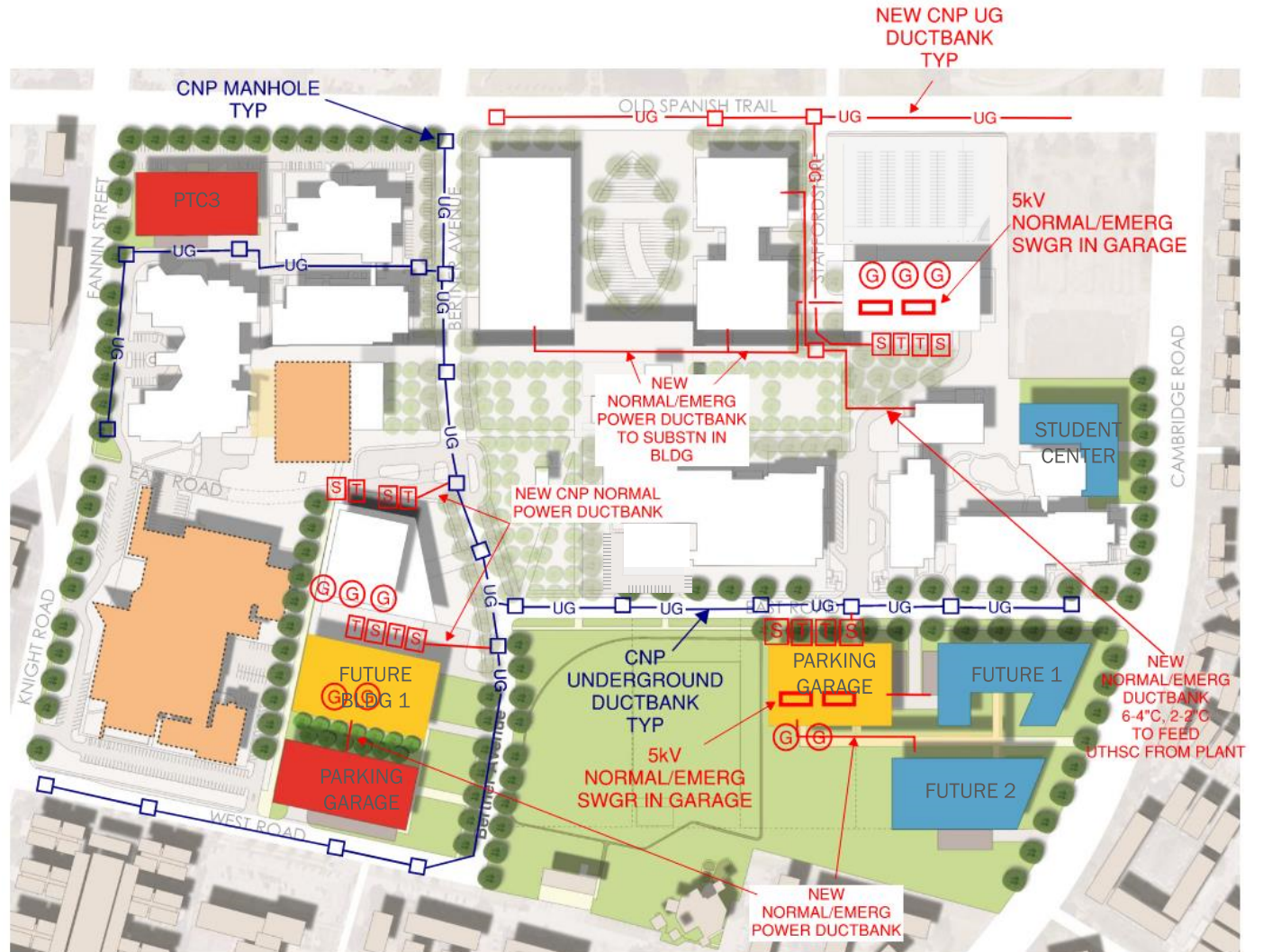

30 Year Plan

30 Year Plan – MD Anderson

MD Anderson Normal Power

Future Buildings 2 and 3

The MD Anderson Future Needs buildings 2 and 3 located West of Bertner will be served from the CNP service located at the parking garage installed as part of the 15-year master plan. As noted previously, the CNP service will consist of two 34.5kV feeders, two 35kV pad mount auto transfer switches and two 5000kVA, 34.5kV-4.16kV pad mount transformers. Two additional transformers, one on either side will be added to accommodate Future Buildings 2 and 3. The CNP transformers will serve MD Anderson owned 5kV, 2000A, Main-Tie-Main Metal Clad Switchgear located in the normal power electrical room within the garage. This 5kV switchgear will serve 4.16kV-480V substations located inside Future Needs Buildings 2 and 3 via underground duct banks. See sheet E016 for the one-line showing this setup.

MD Anderson Future Building 4

This building will be located East of Bertner at the Northeast corner of the site. Normal power will originate at the 5kV normal power switchgear located in the East parking garage and described in the 5-year plan. An underground duct bank will be installed between the MD Anderson Future Needs Building 4 and the garage. 4.16kV-480V substations will be installed in the MD Anderson Building 4 for normal power. See sheet E010 for the one-line showing this setup.

MD Anderson Emergency Power

Future Buildings 2 and 3

The MD Anderson Future Needs buildings 2 and 3 located West of Bertner will be served from an emergency service located at the parking garage installed as part of the 15-year master plan. As noted previously, the emergency service will consist of four 2000kW, 4.16kV natural gas generators and associated 1200A, 5kV paralleling switchgear. This 5kV switchgear will serve 4.16kV-480V substations and associated automatic transfer switches located in Future Needs buildings 2 and 3 via underground duct banks. See sheet E017 for the one-line showing this setup.

MD Anderson Future Building 4

This building will be located East of Bertner at the Northeast corner of the site. Emergency power will originate at the 5kV normal power switchgear located in the East parking garage and described in the 5-year plan. An underground duct bank will be installed between the MD Anderson Building 4 and the garage. 4.16kV-480V substations will be installed in the MD Anderson building for Emergency power. See sheet E011 for the one-line showing this setup.

30 Year Plan – UTHealth

UTHealth Normal Power

Future Building3

The UTHealth Future Building3 located East of Bertner and South of East Road will be served from a CNP service located at the parking garage installed as part of the 15-year master plan. The CNP service will consist of two 34.5kV feeders, two 35kV pad mount auto transfer switches and two 5000kVA, 34.5kV-4.16kV pad mount transformers. The CNP transformers will serve UTHealth owned 5kV, 1200A, Main-Tie-Main Metal Clad Switchgear located in the normal power electrical room within the garage. This 5kV switchgear will serve 4.16kV-480V substations located inside Future Building3 via underground duct bank. See sheet E018 for the one-line showing this setup.

UTHealth Emergency Power

Future Building3

The UTHealth Future Building3 located East of Bertner and South of East Road will be served from an emergency service located at the parking garage installed as part of the 15-year master plan. The emergency service will consist of two 2000kW, 4.16kV natural gas generators and associated 1200A, 5kV paralleling switchgear. This 5kV switchgear will serve 4.16kV-480V substations and associated automatic transfer switches located in Future Building3 via underground duct bank. See sheet E019 for the one-line showing this setup.

The table below shows an estimated load analysis for the different buildings that will be constructed as part of the 30-Year Master Plan.

30-YEAR MASTER PLAN

LOAD	SQ FT	UTILITY DEMAND (W/SQ FT)	EMERGENCY DEMAND (W/SQ FT)	TOTAL UTILITY DEMAND (KW)	TOTAL EMERGENCY DEMAND (KW)
MD ANDERSON Future 2	570,000	4	2	2280	1140
MD ANDERSON Future 3	360,000	4	2	1440	720
MD ANDERSON (OST)	360,000	4	1.5	1440	540
UT Future 3	300,000	4	2	1200	600

30 Year Plan

4. Visualize - Proposed Future State

LEGEND

TYPE	SYMBOL
Existing	
New	
New CNP Underground Ductbank 34.5 Kv	
Genset	
CNP Underground Manhole Existing	
CNP Auto Transfer Primary Switch	
CNP XFMR	
Existing CNP Underground Ductbank 34.5 kv	

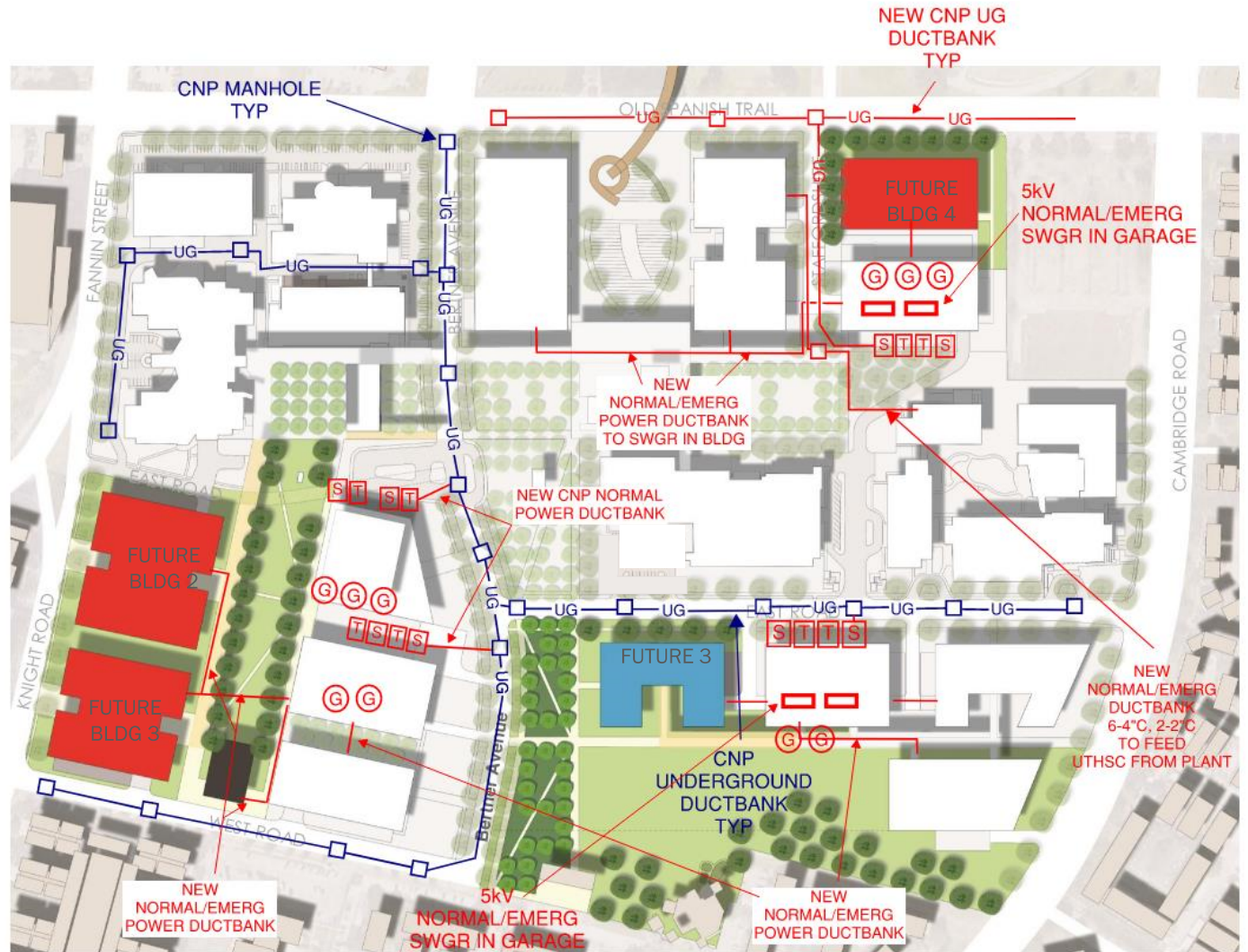

E010 – Site One Line Diagram
MD Anderson SCR5 and Education
Buildings
Normal Power (5-7 Year)

SITE ONE LINE DIAGRAM - MDACC SCR5 AND EDUCATION NORMAL POWER (5-7 YEAR)

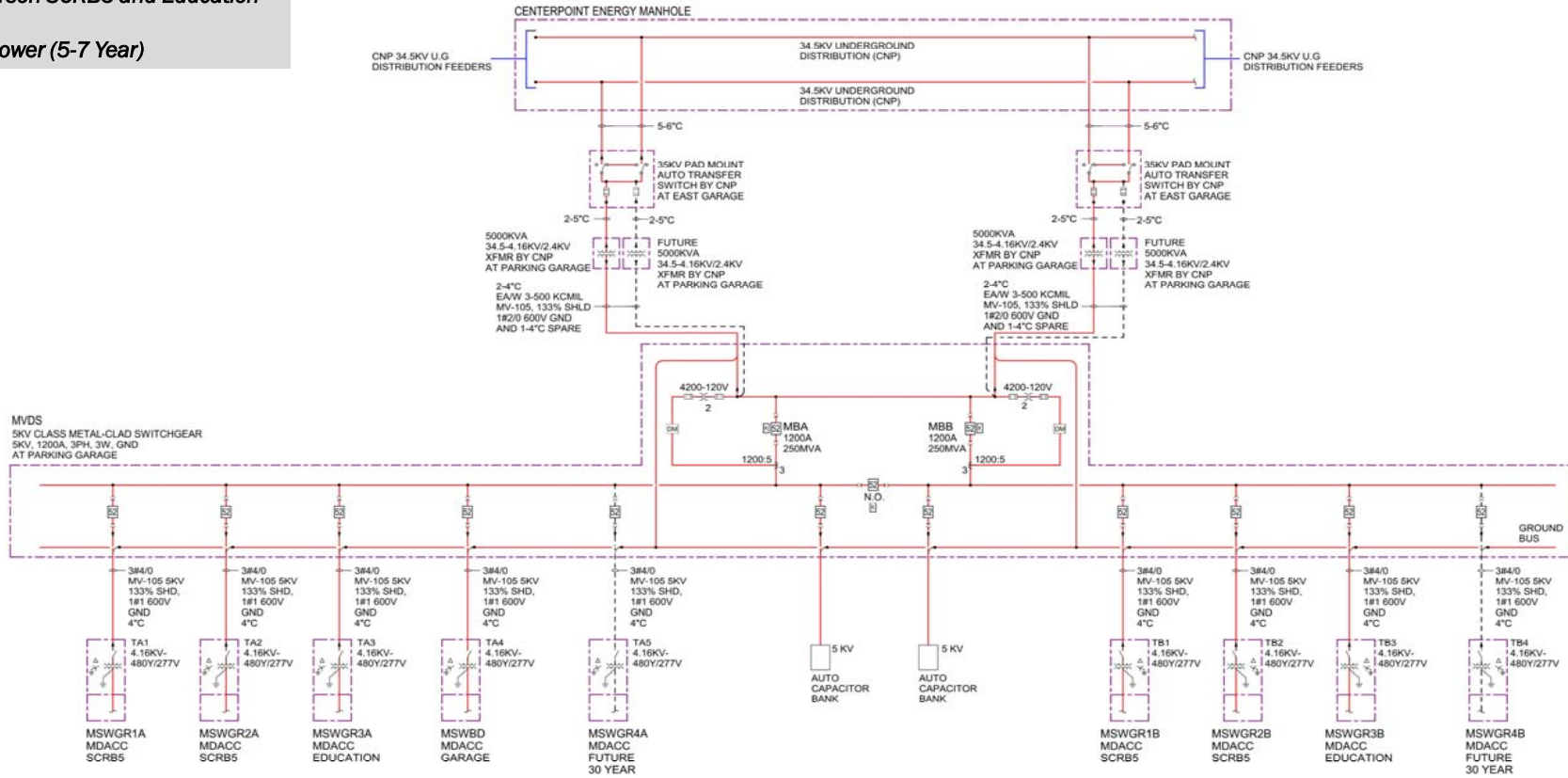

SITE ONE LINE DIAGRAM - MDACC NORMAL POWER SCR5 AND EDUCATION
 1 NORMAL POWER
 NO SCALE

E010

EMERGENCY ONE LINE DIAGRAM - MDACC SCRB5 & EDUCATION (5-7 YEAR)

E011 – One Line Diagram
MD Anderson SCRB5 and Education
Buildings
Emergency Power (5-7 Year)

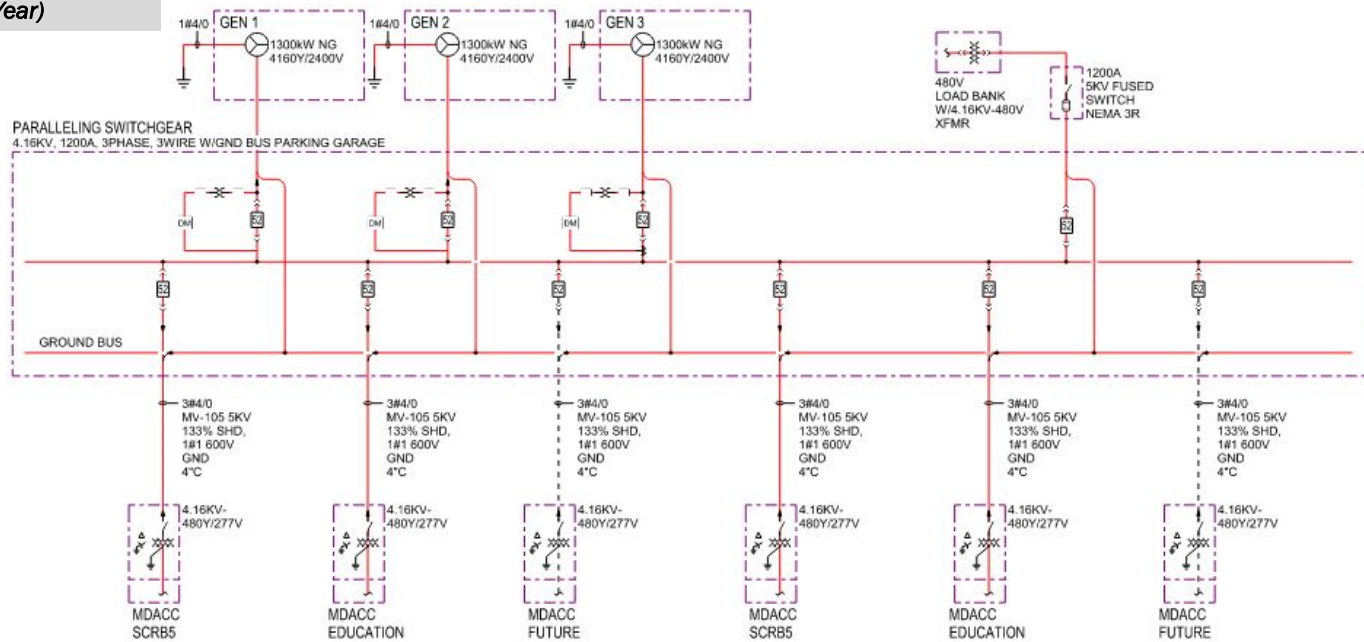

EMERGENCY ONE LINE DIAGRAM - MDACC
 SCRB5 & EDUCATION
 1
 NO SCALE

E011

E012 - One Line Diagram
MD Anderson Vivarium Building
Normal Power (5-7 Year)

ONE LINE DIAGRAM - MDACC VIVARIUM
NORMAL POWER (5-7 YEAR)

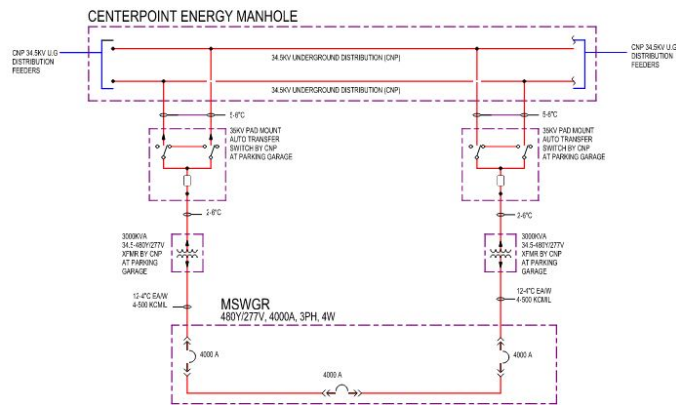

1 ONE LINE DIAGRAM - MDACC VIVARIUM NORMAL POWER (5-7 YEAR)
 NO SCALE

E012

EMERGENCY ONE LINE DIAGRAM MDACC VIVARIUM (5-7 YEAR)

E013 - One Line Diagram
MD Anderson Vivarium Building
Emergency Power (5-7 Year)

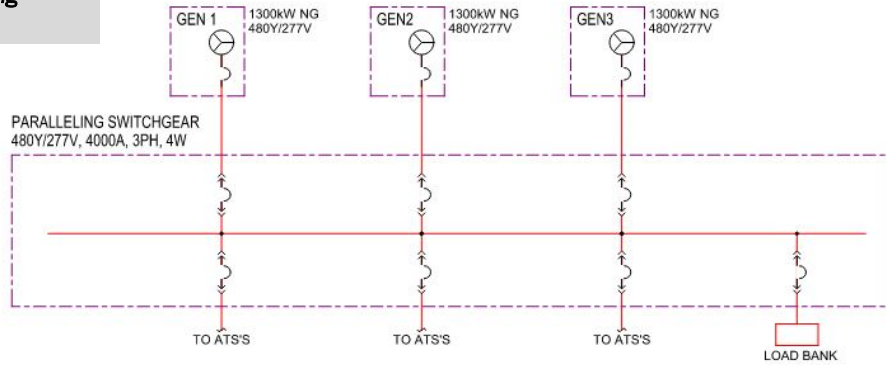

1 EMERGENCY ONE LINE DIAGRAM MDACC VIVARIUM (5-7 YEAR)
NO SCALE

E013

GENERAL NOTES - G014
 A. EXISTING WORK SHOWN LIGHT
 AND NEW WORK SHOWN BOLD.

**E014 - One Line Diagram
 UTHHealth Education Building
 Normal Power (5-7 Year)**

**ONE LINE DIAGRAM -
 UTHSC EDUCATION BLDG
 NORMAL POWER (5-7 YEAR)**

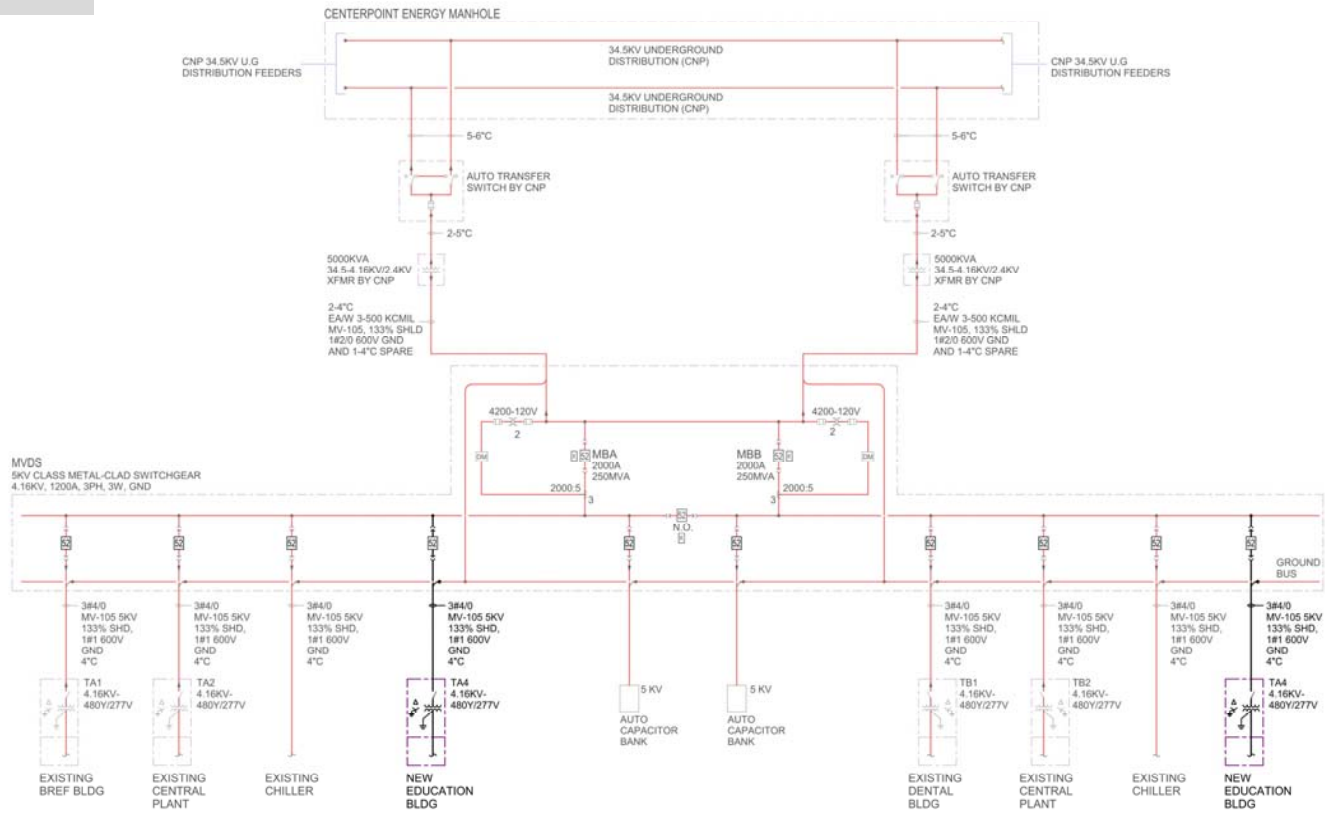

1 ONE LINE DIAGRAM - EDUCATION BLDG NORMAL POWER
REVISED

E014

**E015 – One Line Diagram
UTHealth Education Building
Emergency Power (5-7 Year)**

GENERAL NOTES - G015
A. EXISTING WORK SHOWN LIGHT
AND NEW WORK SHOWN BOLD.

UTHSC EMERGENCY ONE LINE DIAGRAM - EDUCATION BLDG (5-7 YEAR)

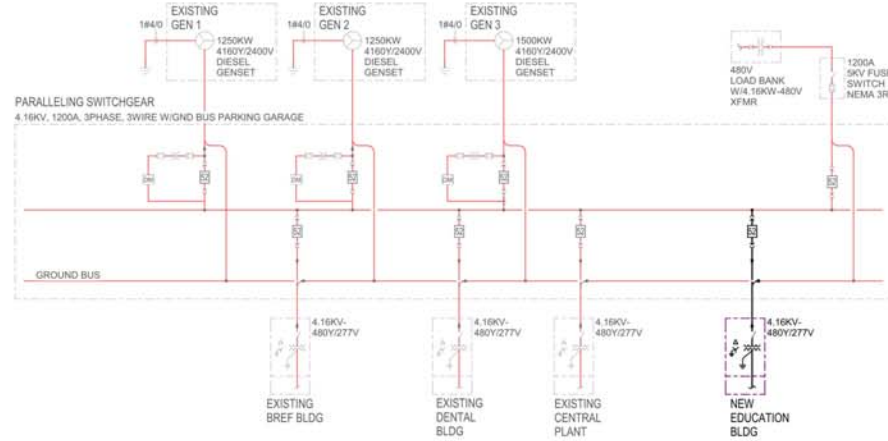

UTHSC EMERGENCY ONE LINE DIAGRAM -
1 EDUCATION BLDG

E015

E016- One Line Diagram
Central Plant, Future Buildings 1-3
Normal Power (15-30 year)

ONE LINE DIAGRAM -
CENTRAL PLANT, RESEARCH BLDG 1-3
NORMAL POWER
15 - 30 YEAR PLAN

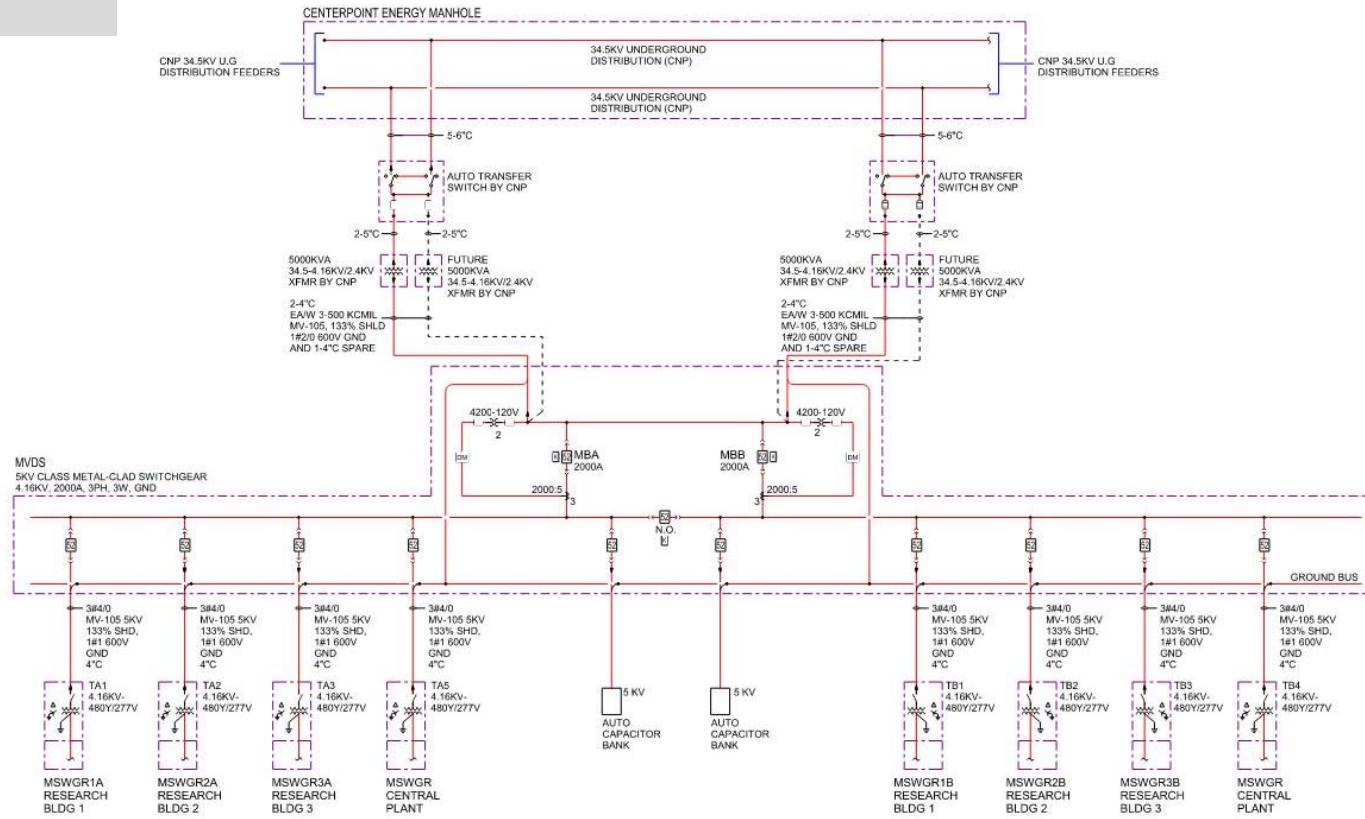

ONE LINE DIAGRAM - CENTRAL PLANT, RESEARCH BLDG 1-3
 NORMAL POWER 15 - 30 YEAR
 NO SCALE

E016

EMERGENCY ONE LINE DIAGRAM - CENTRAL PLANT, RESEARCH BLDG 1-3 15-30 YEAR

E017 - One Line Diagram
Central Plant, Future Buildings 1-3
Emergency Power (15-30 year)

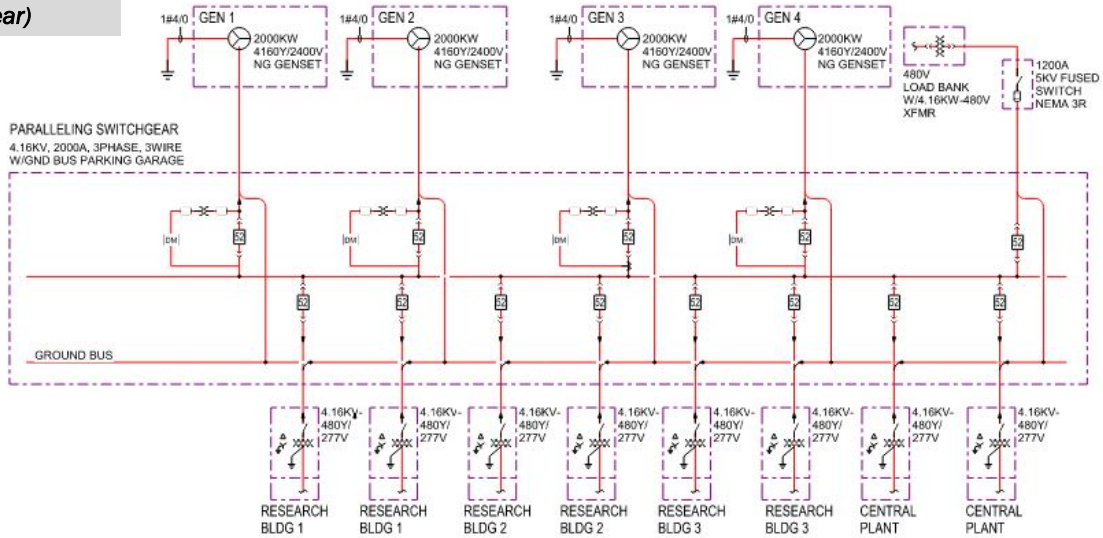

EMERGENCY ONE LINE DIAGRAM - CENTRAL
PLANT, RESEARCH BLDG 1-3, 15 - 30 YEAR
1
NO SCALE

E017

E018- One Line Diagram
UTHealth Future Buildings 1-3
Normal Power (15-30 year)

ONE LINE DIAGRAM -
UTHSC RESEARCH BLDG 1-3
NORMAL POWER (15-30 YEAR)

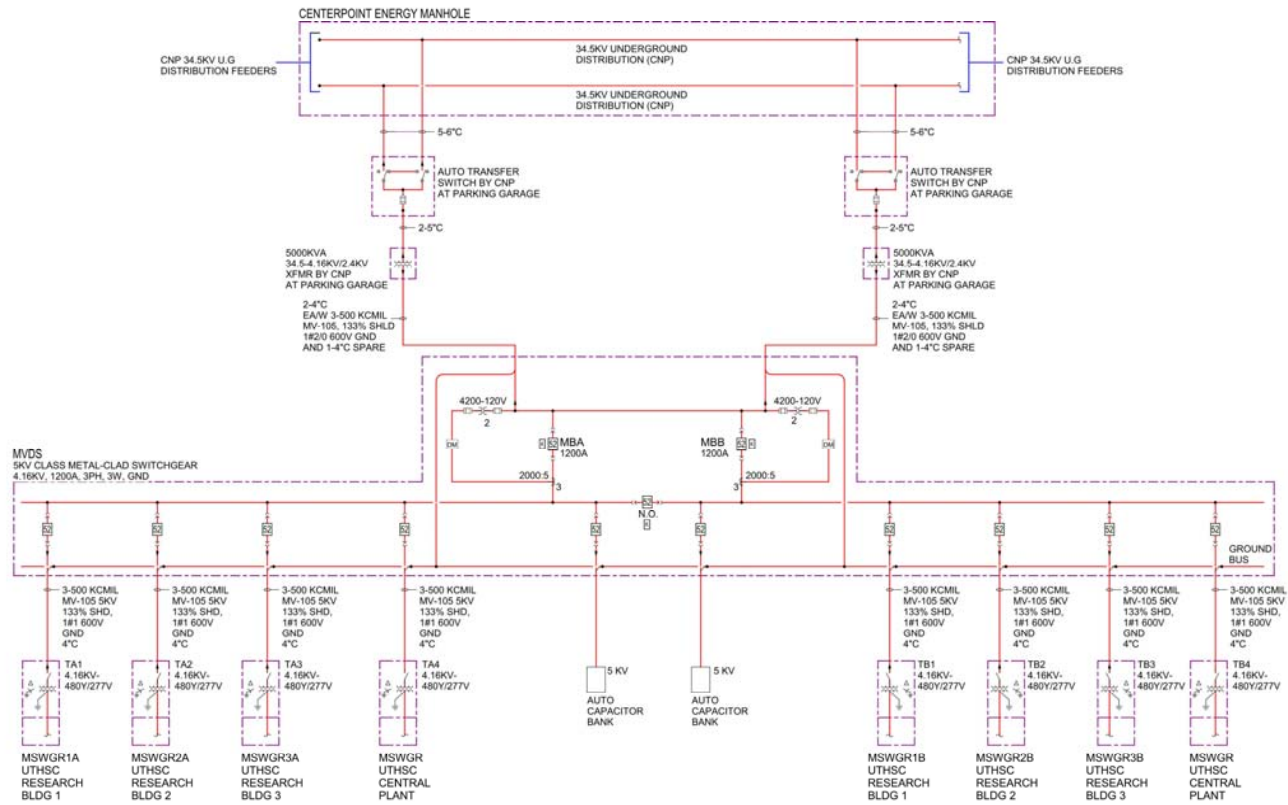

ONE LINE DIAGRAM - UTHSC RESEARCH BLDG
 1-3 NORMAL POWER
 1/30 SCALE

E018

EMERGENCY ONE LINE DIAGRAM - UTHSC RESEARCH BLDG 1-3 (15-30 YEAR)

E019- One Line Diagram
UTHealth Future Buildings 1-3
Emergency Power (15-30 year)

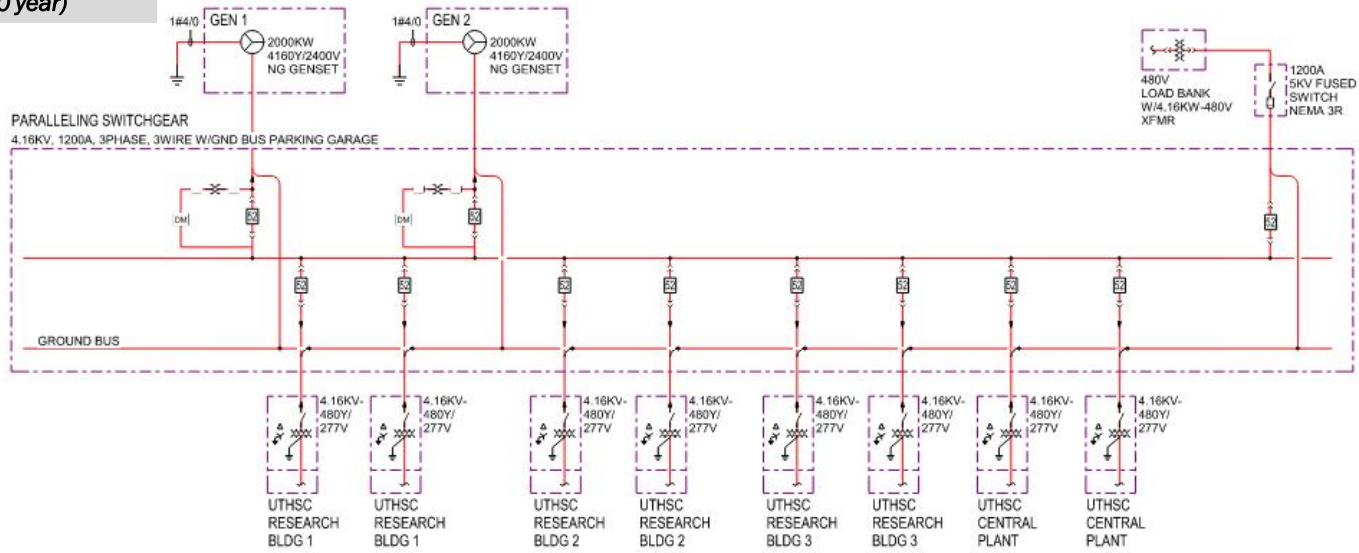

1 EMERGENCY ONE LINE DIAGRAM - UTHSC RESEARCH BLDG 1-3
NO SCALE

E019

Appendix H
South Campus Master Framework

Plumbing and Fire Protection Study



Plumbing Campus Requirements

A domestic water main is to be provided to each future building from the campus domestic water system.

Gas fired domestic water heaters are to be provided to produce domestic hot water in each future building.

A water softener is to be provided in each future building to supply softened water to the domestic water heaters, lab equipment, food service equipment and high purity water production equipment, where applicable.

A domestic water storage tank is to be provided in each future building based on the City of Houston requirements. The water storage tanks are to be sized to storage up to 24 hours of water supply for the building if the campus water supply was interrupted. Additionally, the size of each tank will need to be evaluated with the intent to supplement water to the water well for overall campus use.

Centerpoint Energy is to provide gas service to each future building with a building gas meter and pressure regulator assembly. Natural gas is to power the hydronic boilers and domestic water heaters. Natural gas is also to be supplied to Food Service Equipment, where applicable.

Sanitary sewer is to be provided to each building from the campus sanitary sewer system.

In the future buildings with a Food Service element a grease interceptor and sampling well should be provided buried outside the building.

In the future buildings with a laboratory element a separate lab waste system from the sanitary system is to be provided. A sampling well with electronic monitoring is to be provided outside the building. The lab waste piping is to connect to the sanitary sewer system downstream from the sampling well.

Storm drainage will be routed from each building and connect to the campus storm drainage system.

A diesel fuel storage tank farm is to be provided to supply fuel to the campus emergency generators. One fuel tank farm is to reside on the side of campus east of Bertner Avenue and another fuel tank farm is to reside on the west side of Berner Avenue.

Refer to the South Campus Building Utility Demand Table for projected plumbing and fire protection utility requirements for each future building.

Existing Water Well

The South Campus currently has a water well which serves as an emergency backup water source for the campus.

The water well produces a maximum of 11,460 gallons per hour (191 gpm). The campus currently has a total consumption of 15,050 gallons per hour (251 gpm). Refer to table below for current use by each building.

BUILDING	GALLON PER DAY USE	GALLON PER MINUTE USE
PPR/SRB Vivarium	5500	92
SCRB 1 / SCRB 2	1925	32
Central Plant	7525	126
Main Campus	100	2

Currently, there is a shortfall of 3590 gallons per hour (60 gpm) of the water well serving the entire south campus. As the campus expands the shortfall will increase. Due to this shortfall, the size of domestic water storage tanks for each future building should be evaluated.

5 Year Plan

4. Visualize – Proposed Future State

MD Anderson SCRB5

A 6" domestic water line is to be provided to the building from the campus water distribution system.

CenterPoint Energy is to provide gas service to building with a meter and pressure regulator assembly.

(2) 8" sanitary sewer lines are to be provided serve the building. These will connect to the campus sanitary sewer system.

A grease interceptor is to be provided outside the building. The grease interceptor will serve the food service element in the building.

A 4" lab waste drainage system is to be provided to serve the lab areas. The lab waste system will be independent from the sanitary sewer system extending to outside the building, where an electronically monitored sampling well is to be provided. The discharge from the sampling well is to connect to the sanitary sewer system outside the building.

A roof drainage system is to be provided for the building. Multiple 15" storm sewer lines are to be provided for the building. These will connect to the campus storm drainage system.

A Hazardous Waste Area will be located at the SRB.

MD Anderson Vivarium

A 6" domestic water line is to be provided to the building from the campus water distribution system and from the existing campus water well.

CenterPoint Energy is to provide gas service to building with a meter and pressure regulator assembly.

(2) 8" sanitary sewer lines are to be provided serve the building. These will connect to the campus sanitary sewer system.

A grease interceptor is to be provided outside the building. The grease interceptor will serve the food service element in the building.

A 4" lab waste drainage system is to be provided to serve the lab areas. The lab waste system will be independent from the sanitary sewer system extending to outside the building, where an electronically monitored sampling well is to be provided. The discharge from the sampling well is to connect to the sanitary sewer system outside the building.

A roof drainage system is to be provided for the building. Multiple 15" storm sewer lines are to be provided for the building. These will connect to the campus storm drainage system.

MD Anderson Health Education

A 6" domestic water line is to be provided to the building from the campus water distribution system.

CenterPoint Energy is to provide gas service to building with a meter and pressure regulator assembly.

(2) 6" sanitary sewer lines are to be provided serve the building. These will connect to the campus sanitary sewer system.

A roof drainage system is to be provided for the building. Multiple 15" storm sewer lines are to be provided for the building. These will connect to the campus storm drainage system.

MD Anderson Parking Garage

A roof drainage system is to be provided for the building. Multiple 15" storm sewer lines are to be provided for the building. These will connect to the campus storm drainage system.

A 4" sanitary sewer line is to be provided serve the Hazardous Waste building from the campus sanitary sewer system.

A 3" domestic water line is to be provided to the Hazardous Waste building from the campus water distribution system.

UTHealth Education

A 6" domestic water line is to be provided to the building from the campus water distribution system.

CenterPoint Energy is to provide gas service to building with a meter and pressure regulator assembly.

(2) 6" sanitary sewer lines are to be provided serve the building. These will connect to the campus sanitary sewer system.

A roof drainage system is to be provided for the building. Multiple 15" storm sewer lines are to be provided for the building. These will connect to the campus storm drainage system.

SCRB3 Radiation Vaults

New radiation vaults are proposed to be added to the existing south campus SCRB-3 building on the southwest corner of the structure. The following is the plumbing impact of this proposed addition:

There is a 12" underground storm line, 4" underground Lab waste line, a lab waste sampling well and an 8" underground sanitary sewer line which will be impacted.

Further plan east there is an additional 12" storm line and a 6" sanitary line which also may be impacted. These utilities will need to be extended/rerouted around or to the perimeter of the proposed addition footprint. There is adequate domestic and fire water capacity to service this new addition.

15 Year Plan

4. Visualize – Proposed Future State

UT Parking Garage

A roof drainage system is to be provided for the building. Multiple 15" storm sewer lines are to be provided for the building. These will connect to the campus storm drainage system.

MD Anderson Parking Garage w/ Central Plant

A roof drainage system is to be provided for the building. Multiple 15" storm sewer lines are to be provided for the building. These will connect to the campus storm drainage system.

Additionally, a Central Plant will be part of the Parking Garage footprint.

A 6" sanitary sewer line is to be provided serve the Central Plant from the campus sanitary sewer system.

A 4" domestic water line is to be provided to the Central Plant from the campus water distribution system.

MD Anderson Future Needs Building 1

A 6" domestic water line is to be provided to the building from the campus water distribution system.

CenterPoint Energy is to provide gas service to building with a meter and pressure regulator assembly.

(2) 6" sanitary sewer lines are to be provided serve the building. These will connect to the campus sanitary sewer system.

A 4" lab waste drainage system is to be provided to serve the lab areas. The lab waste system will be independent from the sanitary sewer system extending to outside the building, where an electronically monitored sampling well is to be provided. The discharge from the sampling well is to connect to the sanitary sewer system outside the building.

A roof drainage system is to be provided for the building. Multiple 15" storm sewer lines are to be provided for the building. These will connect to the campus storm drainage system.

MD Anderson Proton Therapy Phase 3

A 4" domestic water line is to be provided to the building from the campus water distribution system.

CenterPoint Energy is to provide gas service to building with a meter and pressure regulator assembly.

(1) 6" sanitary sewer lines are to be provided serve the building. This line will connect to the campus sanitary sewer system.

A roof drainage system is to be provided for the building. (1) 15" storm sewer line is to be provided for the building. This will connect to the campus storm drainage system.

UTHealth Future 1

A 6" domestic water line is to be provided to the building from the campus water distribution system.

CenterPoint Energy is to provide gas service to building with a meter and pressure regulator assembly.

(2) 6" sanitary sewer lines are to be provided serve the building. These will connect to the campus sanitary sewer system.

A 4" lab waste drainage system is to be provided to serve the lab areas. The lab waste system will be independent from the sanitary sewer system extending to outside the building, where an electronically monitored sampling well is to be provided. The discharge from the sampling well is to connect to the sanitary sewer system outside the building.

A roof drainage system is to be provided for the building. Multiple 15" storm sewer lines are to be provided for the building. These will connect to the campus storm drainage system.

UTHealth Future 2

A 6" domestic water line is to be provided to the building from the campus water distribution system.

CenterPoint Energy is to provide gas service to building with a meter and pressure regulator assembly.

(2) 6" sanitary sewer lines are to be provided serve the building. These will connect to the campus sanitary sewer system.

A 4" lab waste drainage system is to be provided to serve the lab areas. The lab waste system will be independent from the sanitary sewer system extending to outside the building, where an electronically monitored sampling well is to be provided. The discharge from the sampling well is to connect to the sanitary sewer system outside the building.

A roof drainage system is to be provided for the building. Multiple 15" storm sewer lines are to be provided for the building. These will connect to the campus storm drainage system.

30 Year Plan

MD Anderson Future Needs Building 2

A 6" domestic water line is to be provided to the building from the campus water distribution system.

CenterPoint Energy is to provide gas service to building with a meter and pressure regulator assembly.

(2) 6" sanitary sewer lines are to be provided serve the building. These will connect to the campus sanitary sewer system.

A 4" lab waste drainage system is to be provided to serve the lab areas. The lab waste system will be independent from the sanitary sewer system extending to outside the building, where an electronically monitored sampling well is to be provided. The discharge from the sampling well is to connect to the sanitary sewer system outside the building.

A roof drainage system is to be provided for the building. Multiple 15" storm sewer lines are to be provided for the building. These will connect to the campus storm drainage system.

MD Anderson Future Needs Building 3

A 6" domestic water line is to be provided to the building from the campus water distribution system.

CenterPoint Energy is to provide gas service to building with a meter and pressure regulator assembly.

(2) 6" sanitary sewer lines are to be provided serve the building. These will connect to the campus sanitary sewer system.

A 4" lab waste drainage system is to be provided to serve the lab areas. The lab waste system will be independent from the sanitary sewer system extending to outside the building, where an electronically monitored sampling well is to be provided. The discharge from the sampling well is to connect to the sanitary sewer system outside the building.

A roof drainage system is to be provided for the building. Multiple 15" storm sewer lines are to be provided for the building. These will connect to the campus storm drainage system.

UTHealth Future 3

A 6" domestic water line is to be provided to the building from the campus water distribution system.

CenterPoint Energy is to provide gas service to building with a meter and pressure regulator assembly.

(2) 6" sanitary sewer lines are to be provided serve the building. These will connect to the campus sanitary sewer system.

A 4" lab waste drainage system is to be provided to serve the lab areas. The lab waste system will be independent from the sanitary sewer system extending to outside the building, where an electronically monitored sampling well is to be provided. The discharge from the sampling well is to connect to the sanitary sewer system outside the building.

A roof drainage system is to be provided for the building. Multiple 15" storm sewer lines are to be provided for the building. These will connect to the campus storm drainage system.

MD Anderson Future Needs Building 4

A 6" domestic water line is to be provided to the building from the campus water distribution system.

CenterPoint Energy is to provide gas service to building with a meter and pressure regulator assembly.

(2) 8" sanitary sewer lines are to be provided serve the building. These will connect to the campus sanitary sewer system.

A roof drainage system is to be provided for the building. Multiple 15" storm sewer lines are to be provided for the building. These will connect to the campus storm drainage system.

Fire Suppression Campus Requirements

Fire Protection Narrative

A fire water line is to be provided to each building from the campus water distribution system. Each building is to be provided with a double check valve, a post indicator and a fire department connection. Buildings which do require a fire pump are to be provided with a fire water break tank as required by the City of Houston. Flow test information will be required in order to determine the size of the break tank.

Timeline

5-7 Year Plan

MD Anderson SCRB5

An 8" fire water line is to be provided to the building from the campus water distribution system for standpipe and sprinkler system.

MD Anderson Vivarium

An 8" fire water line is to be provided to the building from the campus water distribution system for standpipe and sprinkler system.

MD Anderson Education

An 8" fire water line is to be provided to the building from the campus water distribution system for standpipe and sprinkler system.

MD Anderson Parking Garage

An 8" fire water line is to be provided to the building from the campus water distribution system for garage standpipe system.

UTHealth Education

An 8" fire water line is to be provided to the building from the campus water distribution system for standpipe and sprinkler system.

15 Year Plan

UTHealth Parking Garage

An 8" fire water line is to be provided to the building from the campus water distribution system for garage standpipe system.

MD Anderson Parking Garage w/ Central Plant

An 8" fire water line is to be provided to the building from the campus water distribution system for garage standpipe system. Fire water also to serve Central Plant sprinkler system.

MD Anderson Future Building 1

An 8" fire water line is to be provided to the building from the campus water distribution system for standpipe and sprinkler system.

MD Anderson Proton Therapy Phase

3A 8" fire water line is to be provided to the building from the campus water distribution system for sprinkler system.

UTHealth Future 1

An 8" fire water line is to be provided to the building from the campus water distribution system for standpipe and sprinkler system.

UTHealth Future 2

An 8" fire water line is to be provided to the building from the campus water distribution system for standpipe and sprinkler system.

30 Year Plan

MD Anderson Future Building 4

An 8" fire water line is to be provided to the building from the campus water distribution system for standpipe and sprinkler system.

MD Anderson Future Building 2

An 8" fire water line is to be provided to the building from the campus water distribution system for standpipe and sprinkler system.

MD Anderson Future Building 3

An 8" fire water line is to be provided to the building from the campus water distribution system for standpipe and sprinkler system.

UTHealth Future 3

An 8" fire water line is to be provided to the building from the campus water distribution system for standpipe and sprinkler system.

Appendix H
South Campus Master Framework

Additional Documents

Technology Master Plan
Design Guidelines



Technology Master Plan

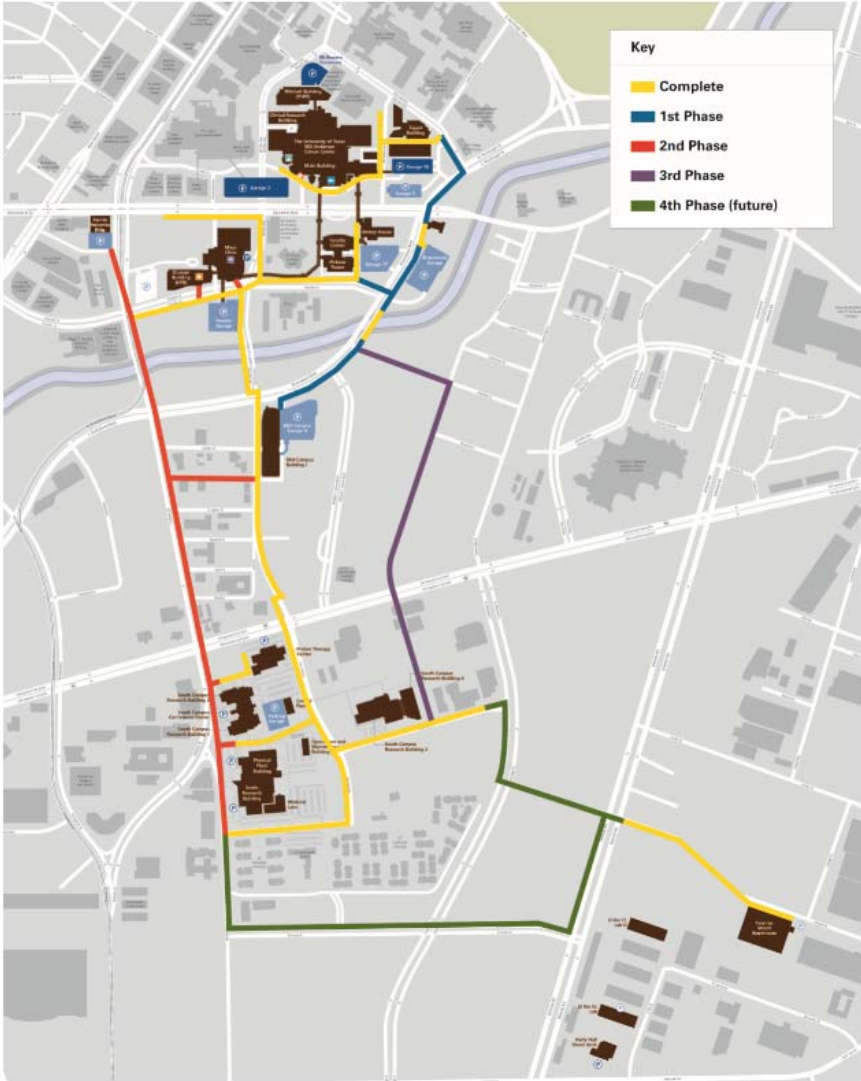

Street Design Guidelines

THE UNIVERSITY OF TEXAS M.D. ANDERSON CANCER CENTER

THE UNIVERSITY OF TEXAS SOUTH CAMPUS MASTER PLAN

THE UNIVERSITY OF TEXAS HEALTH SCIENCE CENTER AT HOUSTON

STREET FRONTAGE ZONE

The typical road section on the campus is 50'-0" wide, accommodating two vehicle lanes and one bike lane in each direction. The road is centered within an 80'-0" right-of-way. The building setback from the right-of-way is 25'-0".

- For all lots, the front setback dimension of 25'-0" serves as the 'build-to' line. Locate buildings as close as possible to this line.
- Plant setbacks with ground cover, turf, trees, shrubs, and seasonal planting from the approved plant list. These setbacks will be flat lands, which allow for sidewalks and planting.
- For tree planting along the major streets (East Road, West Road, and Bertner), provide a minimum of six-inch caliber size with nine-foot clear under canopy height.
- Install automatic irrigation systems for all street frontage landscape.
- Set concrete sidewalks in the 25'-0" building setback. Sidewalks should meander gently within the setback.
- The minimum width of sidewalks is 6'-0". Provide tree planting on each side of the sidewalk for shade and comfort of pedestrian traffic.

At the intersection of Bertner and Old Spanish Trail, a 14'-0" esplanade is provided to accommodate an additional turning bay. At all other intersections, a 12'-0" landscaped median is provided.

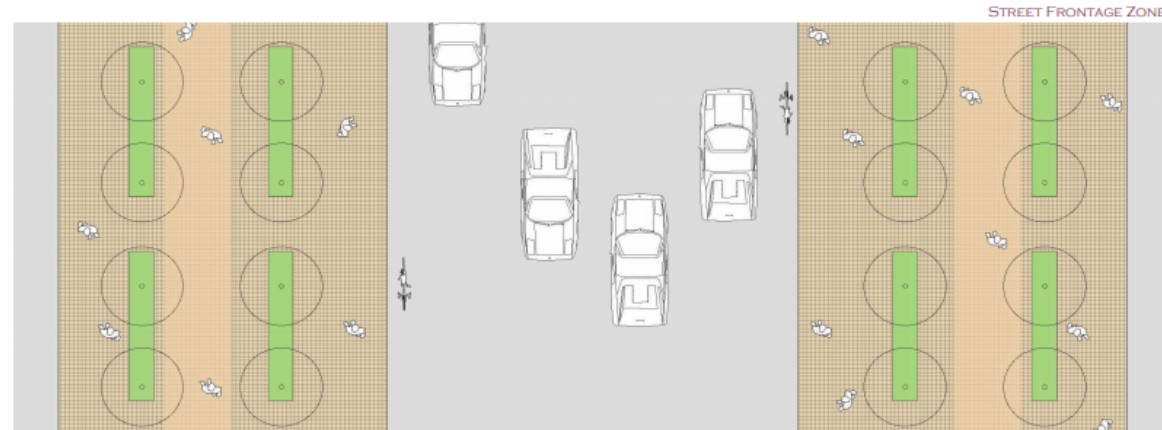
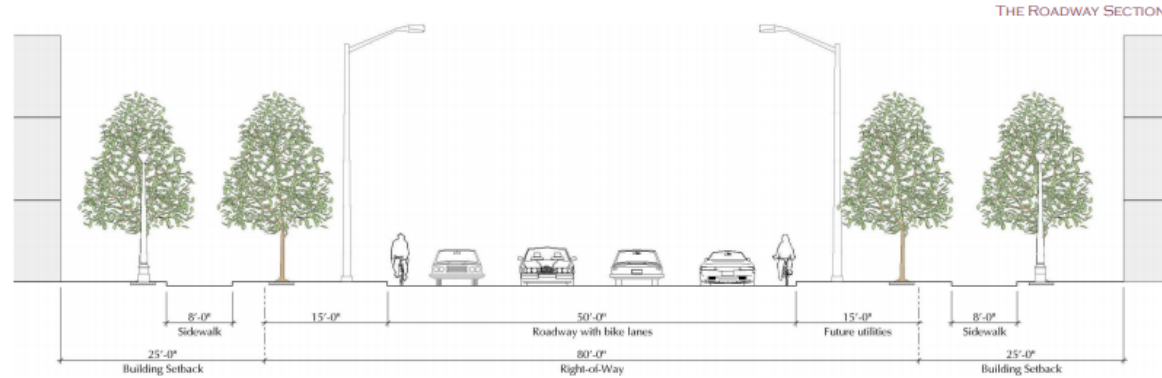

P&W ARCHITECTS, LLP

DESIGN GUIDELINES: SITE DESIGN GUIDELINES

MAY 7, 2004

36

Architectural Guidelines

THE UNIVERSITY OF TEXAS M.D. ANDERSON CANCER CENTER

THE UNIVERSITY OF TEXAS SOUTH CAMPUS MASTER PLAN

THE UNIVERSITY OF TEXAS HEALTH SCIENCE CENTER AT HOUSTON

ARCHITECTURAL GUIDELINES

The buildings of the South Campus, including patient care, educational, and in particular research buildings, should convey a sense of technology, exhibiting metal sculptural elements similar to the metal drums on South Campus Research Building 1 and 2 and the Proton Therapy Center.

The available palette of building materials is purposefully limited in order to obtain a coherent campus image.

Available architectural building finishes include:

- Brick, granite, cast stone, and precast concrete.
- Pre-formed aluminum wall and roof systems.
- Aluminum entrances, storefronts and window wall system.
- Insulated vision glass and spandrel panels.

Architectural building finishes should be applied as follows:

- Employ no more than two masonry materials, with the exception of horizontal accent bands.
- Combine different materials including brick, metal, concrete, and glass.
- Avoid highly reflective glass facades.
- Create a pedestrian scale at the street level by defining the base of buildings with recesses, colonnades, awnings, etc.
- Parking garages will match existing Garage No. 1.
- Provide screening for exposed rooftop mechanical devices on buildings.

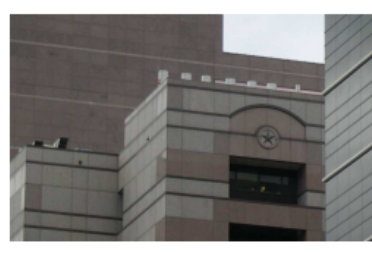

SITE DENSITY STANDARDS

In order to achieve a level of density characteristic of an urban technology campus, the following site density standards are to be utilized:

- A minimum of 25 percent of the development will be green/open space.
- It is recommended that research buildings should be four stories, to minimize the effects of detrimental emissions by controlling height relationship between emitters and receivers.
- Buildings, other than research buildings, will be a minimum of two stories.
- A plume study is required for all building except non-emitters with their highest intake 45 feet or under.
- All buildings greater than four stories are to be located on one of the identified 'anchor' sites.
- A wind tunnel study is required for all buildings.
- Orient buildings similar to that shown on the site phasing plans.
- The maximum building area is not restricted, as long as it meets all other standards listed herein and building code requirements.
- The gross building area, including parking garage, on a development site will be no less than 1.5 times the area of the site.
- The minimum floor plate of a building, including the floor plate of the parking garage, will be no less than 40 percent of the area of the site.

A table of these development standards and the resulting density of proposed building sites is located in *Appendix C*.

P&W ARCHITECTS, LLP

DESIGN GUIDELINES: ARCHITECTURAL GUIDELINES

MAY 7, 2004

37

Landscape Guidelines

THE UNIVERSITY OF TEXAS M.D. ANDERSON CANCER CENTER

THE UNIVERSITY OF TEXAS SOUTH CAMPUS MASTER PLAN

THE UNIVERSITY OF TEXAS HEALTH SCIENCE CENTER AT HOUSTON

LANDSCAPE GUIDELINES

The landscape is an integral part of the South Campus and a minimum of 25 percent of each development pad will be maintained as green space. In conjunction with the building setback and the Village Courts, these green spaces are meant to encourage user interaction for passive uses, informal gatherings, and recreation.

The landscape design concept is as follows:

- Create attractive, strong open spaces, interconnected throughout the campus, that permit user interaction.
- Utilize landscape to create a strong campus identity.
- Encourage the placement of landscape to define special places, such as street intersections and courtyards.
- Encourage the development of landscape that reinforces the street edge and the pedestrian environment.
- Utilize landscape to appropriately scale building masses at the street level.
- Create a landscape that will enhance long term property values.
- Provide a level of visual continuity and unity to the development sites' perimeter.
- Provide pedestrian scale circulation throughout the campus to encourage exercise and outdoor activity.



Landscape treatments for each building site shall be in the form of shade trees, ornamental trees, shrubs, groundcovers and grasses. Planting shall provide shade for parking and pedestrian areas, identify site and building entrances, enhance views into the site and out to the surroundings, reinforce architectural form and scale, screen and buffer service dock areas.

On property held for future development, the tenant must install turf grass or groundcover in the areas within any street or parking area and must establish or re-establish vegetation generally to control erosion.

Each tenant must provide a minimum of 50 trees per acre of non-paved surfaces and plant them in the proposed development site. Two ornamental trees may be substituted for one (1) shade tree. Shade trees must be a minimum of six inch (6") caliber size and ornamental trees must be a minimum of six feet (6') high. These tree-planting requirements are in addition to those required in the Street Frontage Zone. All tree and plant species shall be selected from the approved plant list located in Appendix D, and as shown on the following pages.



P&W ARCHITECTS, LLP

DESIGN GUIDELINES: LANDSCAPE GUIDELINES

MAY 7, 2004

38

Landscape Guidelines

THE UNIVERSITY OF TEXAS M.D. ANDERSON CANCER CENTER

THE UNIVERSITY OF TEXAS HEALTH SCIENCE CENTER AT HOUSTON

THE UNIVERSITY OF TEXAS SOUTH CAMPUS MASTER PLAN

SMALL TREES

ITALIAN CYPRESS



SOUTHERN WAX MYRTLE



RIVER BIRCH



JAPANESE PERSIMMON



BRADFORD PEAR



REDBUD



YALPON



Landscape Guidelines

THE UNIVERSITY OF TEXAS M.D. ANDERSON CANCER CENTER

THE UNIVERSITY OF TEXAS HEALTH SCIENCE CENTER AT HOUSTON

THE UNIVERSITY OF TEXAS SOUTH CAMPUS MASTER PLAN

MEDIUM AND LARGE TREES

NUTTALL OAK



LIVE OAK



SOUTHERN MAGNOLIA



DATE PALM



SHUMARD OAK



BALD CYPRESS



MEXICAN SYCAMORE



WATER OAK



RED OAK



DRAKE ELM



Landscape Guidelines

THE UNIVERSITY OF TEXAS M.D. ANDERSON CANCER CENTER

THE UNIVERSITY OF TEXAS SOUTH CAMPUS MASTER PLAN

THE UNIVERSITY OF TEXAS HEALTH SCIENCE CENTER AT HOUSTON

PERENNIALS

BUTTERFLY BUSH



RUDBECKIA



PURPLE SALVIA



PLUMBAGO



MEXICAN BUSH SAGE



GULF COAST PENSTEMON



DESIGN GUIDELINES:

LANDSCAPE GUIDELINES

P&W ARCHITECTS, LLP

MAY 7, 2004

41

Landscape Guidelines

THE UNIVERSITY OF TEXAS M.D. ANDERSON CANCER CENTER

THE UNIVERSITY OF TEXAS SOUTH CAMPUS MASTER PLAN

THE UNIVERSITY OF TEXAS HEALTH SCIENCE CENTER AT HOUSTON

SHRUBS AND PLANTS

BUTTERFLY IRIS



PHILODENDRON



WAX MYRTLE



AGAPANTHUS



HIBISCUS



GREEN ARBORVITAE



CHERRY LAUREL



AFRICAN IRIS BICOLOR



TEXAS SAGE



CONFEDERATE



WISTERIA



P&W ARCHITECTS, LLP

MAY 7, 2004

DESIGN GUIDELINES: LANDSCAPE

GUIDELINES

42

Landscape Guidelines

THE UNIVERSITY OF TEXAS M.D. ANDERSON CANCER CENTER
THE UNIVERSITY OF TEXAS HEALTH SCIENCE CENTER AT HOUSTON

THE UNIVERSITY OF TEXAS SOUTH CAMPUS MASTER PLAN

SHRUBS AND PLANTS (CONTINUED)

ORNAMENTAL GRASSES



Landscape Guidelines

THE UNIVERSITY OF TEXAS M.D. ANDERSON CANCER CENTER
THE UNIVERSITY OF TEXAS HEALTH SCIENCE CENTER AT HOUSTON

THE UNIVERSITY OF TEXAS SOUTH CAMPUS MASTER PLAN

VINES AND GROUND COVERS

CLIMBING FIG



LADY BANKSIAE ROSE



CAROLINA YELLOW JESSAMINE



WEDELIA



GIANT LIRIOPE

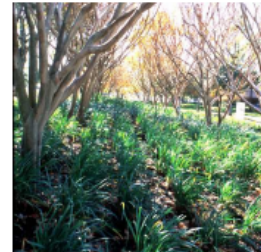

Signage Guidelines

THE UNIVERSITY OF TEXAS M.D. ANDERSON CANCER CENTER

THE UNIVERSITY OF TEXAS SOUTH CAMPUS MASTER PLAN

THE UNIVERSITY OF TEXAS HEALTH SCIENCE CENTER AT HOUSTON

SIGNAGE GUIDELINES

The wayfinding signage strategy for the South Campus will reflect and clarify the larger organizational design themes that define the Research Park and the South Campus as a whole. These themes include two specific wayfinding strategies: a comprehensive vehicular and pedestrian wayfinding system developed by the Texas Medical Center and a 'pathways and hubs' wayfinding system developed by M. D. Anderson. Relevant parts of both systems should be present on the South Campus. In addition, identity signage for the Research Park should be developed to communicate wayfinding and identity information specific to the Research Park.



Graphic elements can promote a particular identity in major public spaces.



The design of signage elements can emphasize the high tech nature of the campus development.



Directories can help users understand their surroundings by providing a wide range of information.



Three-dimensional maps are a very effective tool for wayfinding. They can render the surrounding landscape immediately comprehensible.

NAMING STRATEGY

The University of Texas Research Park is a joint venture of the University of Texas at M. D. Anderson Cancer Center and The University of Texas Health Science Center at Houston. Individually, the institutions have highly recognizable brands, one component of which they share (The University of Texas). The University of Texas is well recognized as a leader in technology and research. Any brand position strategy should capitalize on this alignment of brand components.

The public face of the new south campus development will be The University of Texas Research Park. Brand positioning will promote the entity's various research activities, as well as the various patient care facilities located within. Any and all promotional material will reflect this. M. D. Anderson and UT Health Science Center, as partners in the venture, will also have recognition, but secondary to the primary brand.

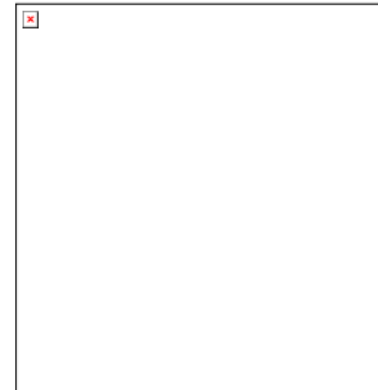

Signage Guidelines

THE UNIVERSITY OF TEXAS M.D. ANDERSON CANCER CENTER

THE UNIVERSITY OF TEXAS SOUTH CAMPUS MASTER PLAN

THE UNIVERSITY OF TEXAS HEALTH SCIENCE CENTER AT HOUSTON

THE WAYFINDING SYSTEM

The wayfinding system consists of a network of "Health Pathways" that connects major public spaces that serve as orientation landmarks within the Research Park.

THE HEALTH PATHWAY

The Health Pathway is a pedestrian that is separated from vehicular traffic by a zone of landscaping (see the street section). This will create a comfortable circulation zone that will encourage healthy alternatives to automotive transit. The pathway will be augmented with signage and information graphics that will direct travelers to their destination while informing them of the healthy benefits of pedestrian activity.

MAJOR PUBLIC SPACES

The major public spaces have distinct personalities that express different climactic zones in Texas. The different characteristics allow the spaces to serve as landmarks that reinforce users' understanding of where they are and where they are heading.

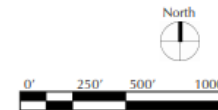

P&W ARCHITECTS, LLP

DESIGN GUIDELINES: SIGNAGE GUIDELINES

MAY 7, 2004

46

Signage Guidelines

THE UNIVERSITY OF TEXAS M.D. ANDERSON CANCER CENTER

THE UNIVERSITY OF TEXAS SOUTH CAMPUS MASTER PLAN

THE UNIVERSITY OF TEXAS HEALTH SCIENCE CENTER AT HOUSTON

SIGNAGE TYPES

Elements of multiple wayfinding systems will be present on the South Campus. The Texas Medical Center's wayfinding system includes vehicular and pedestrian signs. Extending the TMC signs into the South Campus will permit a single set of wayfinding signs to offer direction to first-time visitors, no matter where their destination is located. The campus will be represented by two sign types: gateway signage that will indicate major points of entry and building monuments that will provide a common format for institution and building identification within the Research Park and other facilities. It is anticipated that institutions represented within the Research Park may also provide some other forms of identity, such as M. D. Anderson's perimeter banners.

The signs on this page are components of the Texas Medical Center's family of wayfinding signs. Components of the M. D. Anderson and Research Park families of signs are shown on the following page.

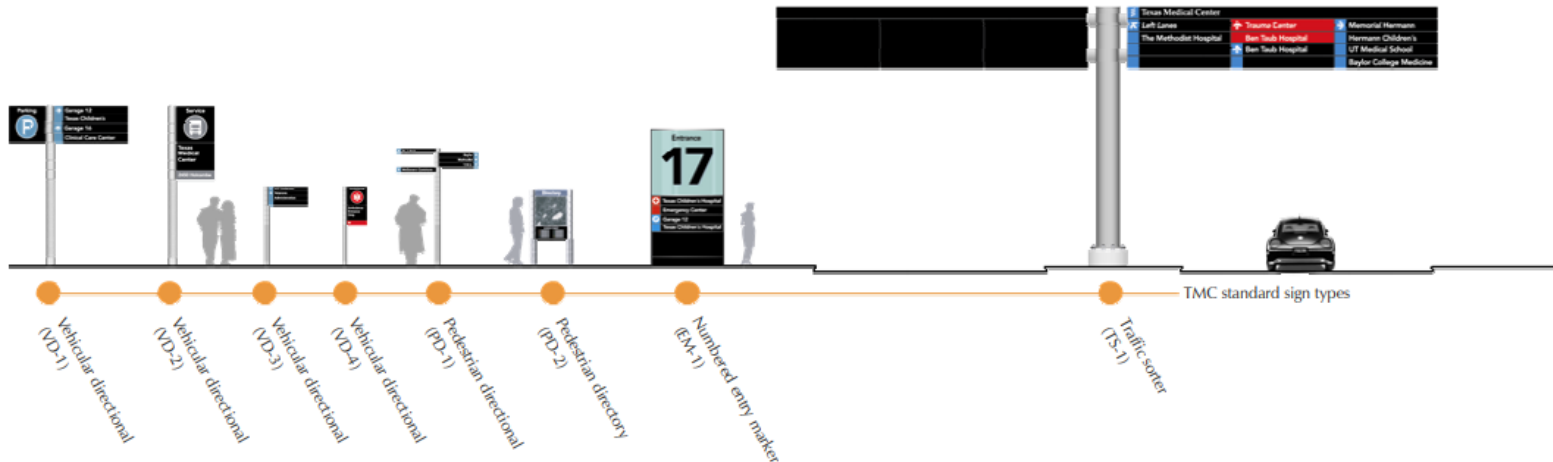

Signage Guidelines

THE UNIVERSITY OF TEXAS M.D. ANDERSON CANCER CENTER
THE UNIVERSITY OF TEXAS HEALTH SCIENCE CENTER AT HOUSTON

THE UNIVERSITY OF TEXAS SOUTH CAMPUS MASTER PLAN

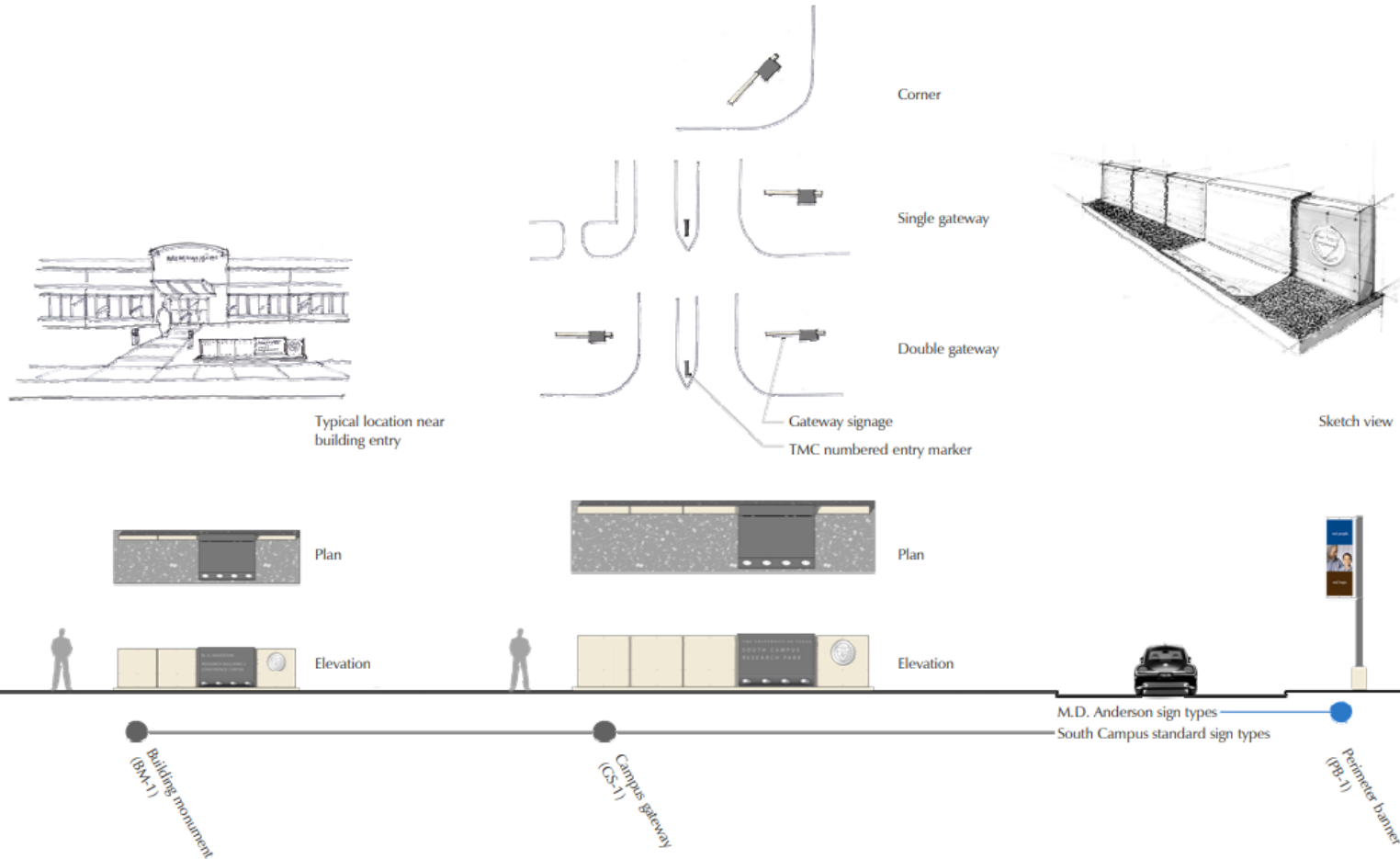

Signage Guidelines

THE UNIVERSITY OF TEXAS M.D. ANDERSON CANCER CENTER
THE UNIVERSITY OF TEXAS HEALTH SCIENCE CENTER AT HOUSTON

THE UNIVERSITY OF TEXAS SOUTH CAMPUS MASTER PLAN

SIGNAGE LOCATION PLAN



● Vehicular directionals (TMC)



● Numbered entry markers (TMC)



● Traffic sorters (TMC)



● Perimeter banners (MDACC)



● Gateway signage (South Campus)



● Building monument signage (South Campus)

The plan to the right shows the desired locations of the primary sign types indicated.

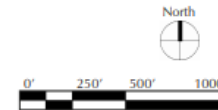

P&W ARCHITECTS, LLP
MAY 7, 2004

DESIGN GUIDELINES: SIGNAGE GUIDELINES

Signage Guidelines

THE UNIVERSITY OF TEXAS M.D. ANDERSON CANCER CENTER

THE UNIVERSITY OF TEXAS SOUTH CAMPUS MASTER PLAN

THE UNIVERSITY OF TEXAS HEALTH SCIENCE CENTER AT HOUSTON

BUILDING SIGNAGE

Wayfinding within the Research Park can be made difficult by the numerous names by which a building can be called. A building may be signed with an institution name or names, a donor name, and a functional name. The general guidelines illustrated on this page constitute an effort to create a consistent visual hierarchy for building signage on buildings within the South Campus.

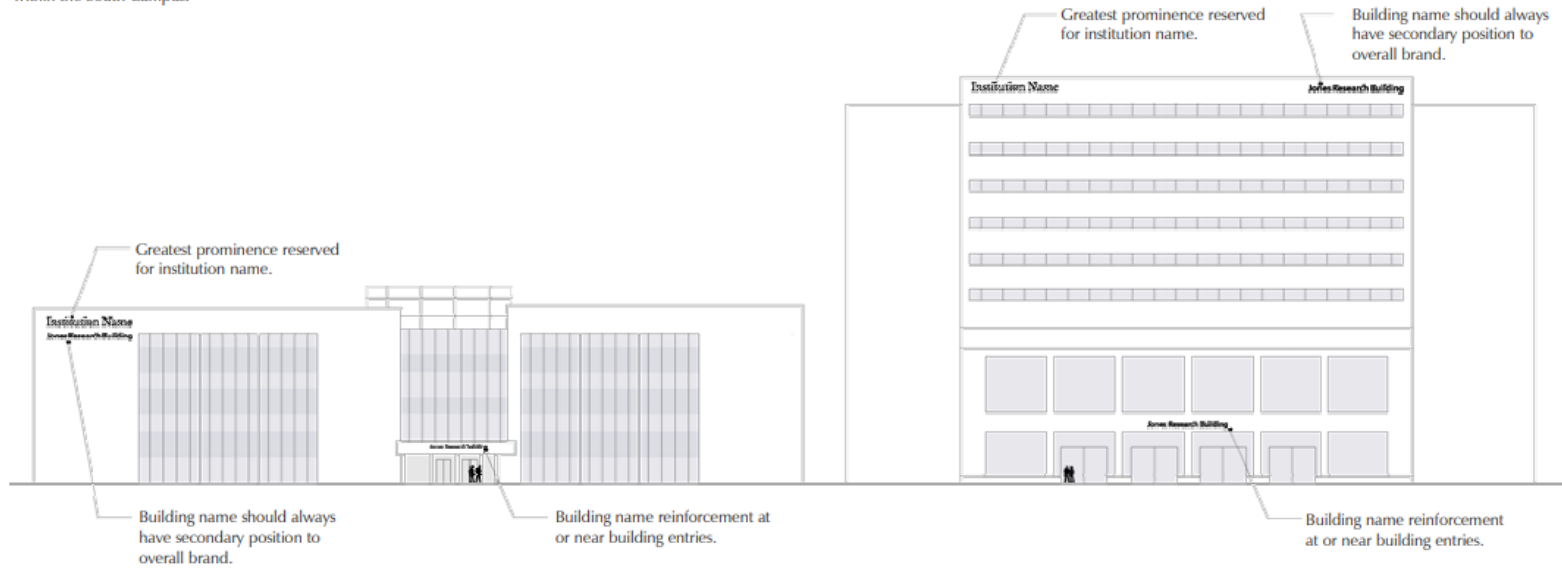

Site Development Guidelines

THE UNIVERSITY OF TEXAS M.D. ANDERSON CANCER CENTER

THE UNIVERSITY OF TEXAS SOUTH CAMPUS MASTER PLAN

THE UNIVERSITY OF TEXAS HEALTH SCIENCE CENTER AT HOUSTON

SITE DEVELOPMENT GUIDELINES

FENCES, SCREENS, WALLS

Fences, Screens, and Walls shall be used where necessary to provide aesthetic value, practical boundary, and/or provide a strong sense of privacy or security.

The barrier should coincide with the surrounding architectural elements, landscape context, and in most cases should be visually attractive on both sides.

Prior to installation, it shall be determined if barrier should be solid in appearance or allow for some degree of visual accessibility. The "harmony" of the fence with surrounding features should also be addressed. It should also be determined if the barrier is to be planted and whether that planting shall be heavy or for accent only.

Barrier material shall be high in quality. The following materials are acceptable:

- Metal: Aluminum with powder coat rust treatment or approved primer. Shall be painted or finished in a professional manner.
- Masonry: A variety of masonry is acceptable but shall be aesthetically pleasing and relate to architectural elements and building materials. CMU is also acceptable, and shall meet the same requirements as stone.

The proposed fence, screen, or wall must comply with all relevant legal and building code requirements. Design minimums should be determined by these codes and specified heights, minimum and maximum, are mandatory and must be followed.

Barriers shall be proportional to the surrounding space and user function, and should not be scaled to detract from the appearance of adjacent buildings or properties, become a nuisance or hazard, alter storm water runoff patterns, or create off-site problems. These items should be addressed and resolved prior to any construction.

BUILDING LANDSCAPE

To create a transition between buildings and parking areas, a minimum of twenty-thousand square foot landscape zone is required for lots of 3-acres and above. This landscape zone is required between building perimeters and any associated parking.

This area is to be planted with trees, shrubs, groundcovers and grasses. Turf is also allowed. It is also recommended to include water features or special features such as arbors, terraces, and outdoor seating to encourage outdoor activity. Plantings should be arranged in a hierarchy of heights stepping up from low turf and groundcover near the streets or perimeter to progressively higher groundcover and shrubs close to the building.

Landscaping next to parking garages must include screen trees and continuous lines of shrubs to reduce the visual impact of these structures.

All landscape plants must be from the approved plant list.

SITE LIGHTING

Lighting shall be provided for vehicular, pedestrian, signage, architectural and site features.

Light fixtures shall be of a consistent and uniform design. Light sources shall be metal halide. Yellow/orange source lights are prohibited from use. Flood lighting is prohibited from use.

Pedestrian walks, courts, gardens, site and building entrances shall be illuminated to enhance the pedestrian qualities of the development. Low level fixtures should compliment the overall architectural design and focus on lighting site features such as fountains, sculpture, and other site amenities.

Illumination must commence automatically one hour before sunset and last until the building site is closed for the evening. Parking structures and pedestrian walks and sitting areas must be illuminated automatically during all hours of darkness and when poor weather conditions warrant.

SIDEWALKS

Sidewalks are to be constructed between the street and building within the building setback zone. All sidewalk construction must meet City of Houston design standards. All walks must be constructed in a consistent workmanlike manner.

Sidewalks shall be a minimum of six feet (6'-0") wide and shall be set within the predetermined walk easements. The path of the sidewalk shall gently meander with the setback similarly to that shown on the Phasing Plans. Gentle radii instead of abrupt curves and angles are required for transition portions of the sidewalks.

Sidewalks are to be a minimum of four inch (4") thick concrete constructed over a sand base, meeting the City of Houston design standards.

No cold joints are permitted and complete pours between expansion joints are required. Drill dowels into existing concrete curbs and driveways and use expansion joints at connections of existing and new concrete. Dowels are to be stubbed out where sidewalk is to be continued in the future.

Best efforts shall be made to match sidewalk elevations with the existing manhole and valve box elevations.



P&W ARCHITECTS, LLP

MAY 7, 2004

DESIGN GUIDELINES: SITE DEVELOPMENT GUIDELINES

51

Site Development Guidelines

THE UNIVERSITY OF TEXAS M.D. ANDERSON CANCER CENTER

THE UNIVERSITY OF TEXAS SOUTH CAMPUS MASTER PLAN

THE UNIVERSITY OF TEXAS HEALTH SCIENCE CENTER AT HOUSTON

ACCESS POINTS AND DRIVEWAYS

All access roads and driveways shall meet City of Houston standards. Driveways and access roads accessing any of the properties boundary roads, including Old Spanish Trail, Cambridge, El Paseo St, and Knight/Fannin, shall meet all Texas Department of Transportation requirements. To the extent necessary, driveways can be shared by adjacent properties. Access road and driveway locations shall be determined from the centerline of the road or driveway. They shall intersect with public streets at angles of 90 degrees. Driveways shall meet minimum width requirements, shall be paved in concrete, curbed and guttered with minimum curb radii in accordance with City standards.

Maintain proper visibility at all public street access points and intersections. Fences, walls, screens, signs, structures, planting hedges and tree foliage, if placed near or within the visibility triangles, shall meet City of Houston standards.

GRADING AND DRAINAGE

All grading shall be done to alleviate ponding of water on site. Depressions on paved or landscaped areas, which will allow the unintentional ponding of water, are not permitted. Grading in all landscaped areas must provide smooth transitions in grade elevations. Slopes on lawn areas shall not exceed 3:1 and must have a minimum slope of 2% to facilitate drainage. Steeper slopes more than 3:1 are allowed as an exception, but must be covered in groundcovers, soil savers, and/or approved retainer devices to provide protection from erosion.

Berming is allowed and can be used to facilitate partial planting screenings of parking garages, utilities, and storage areas on site. Berming can also be used to screen short term parking and drop-off areas provided that the minimum slope gradients are used within the required parking setback areas. Drainage swales must be shallow, gently contoured and sloped to minimize erosion. Concrete riprap, trapezoidal concrete channels and concrete pilot channel ditches are not permitted.

DROP-OFF AREAS

Drop-off areas must be paved with colored concrete and curbed and guttered with concrete in accordance with the development standards promulgated by the City of Houston.

Drop-off areas shall have landscaping treatment. At minimum, landscaping at the drop-off areas shall contain both trees and ground cover treatment. The landscaping areas require subsurface drainage and automatic irrigation.

Parking areas must be sufficient to accommodate all parking needs for employees, company vehicles, and visitors without the use of on street parking. If parking needs increase on any building site, additional off street parking must be provided by the tenant in accordance with the development standards promulgated by the City of Houston.

Short-term parking and drop-off areas shall be screened from public streets with the use of shrubs, berming, and (or) walls, with a minimum height of 36".

No wheel guards or barriers shall be allowed in any short term parking areas.

SERVICE AND LOADING AREAS

Service areas shall be located at the side or back of buildings, away from public view, or in a separate structure altogether. Such areas must not be visible from streets. No service or delivery vehicle may park or load/unload along public streets, or primary visitor drop-off areas.

Service areas, and loading/unloading areas must be completely screened from public view.

Except to the extent such restriction is prohibited by applicable law, no external antenna, dish, tower or similar structure shall be erected or maintained on any building site, or in any building constructed thereon.

Dumpsters shall be located within only the side yard areas of each site. Dumpsters or other trash receptacles shall be screened with fences and/or walls

that match the building material colors. The height of the screen walls shall be a minimum one foot (1') above the top of the trash container.

Utility boxes, utility transformers, meters and other equipment which must be located above ground must be screened from view from public streets and parks with mass planting or a solid wall to match the building's material and color. The planting or screen wall must be a minimum of one foot (1') higher than the equipment or utility box, in order to adequately screen it from public areas.

See: *Fences, Screens, Walls*

IRRIGATION

Irrigation is important to protect the investment of the landscaping. For all landscaped areas, a moisture level shall be provided in an amount and frequency to provide growth of plant materials on a permanent basis. Irrigation systems shall be installed prior to landscape inspection of any site. The irrigation system shall be designed and maintained to provide efficient and adequate water distribution.

The following methods of irrigation are acceptable:

- A conventional underground automatic controlled irrigation system including conventional rotor, spray, or bubbler type heads.
- Temporary above ground irrigation system shall be acceptable for areas utilizing xeriscape plants, native grasses, and wildflowers.
- An above ground irrigation system shall be acceptable for the first two growing seasons only.

Irrigation shall not be required for natural or undisturbed areas.

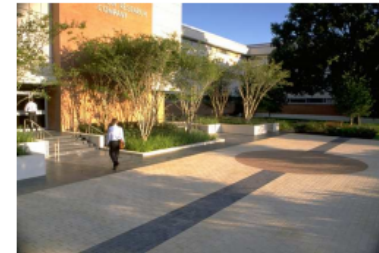

Site Development Guidelines

THE UNIVERSITY OF TEXAS M.D. ANDERSON CANCER CENTER

THE UNIVERSITY OF TEXAS SOUTH CAMPUS MASTER PLAN

THE UNIVERSITY OF TEXAS HEALTH SCIENCE CENTER AT HOUSTON

MAINTENANCE

The Owners of any Building Site shall, jointly and severally, have the duty and responsibility, at their sole cost and expense, to keep that part of the Development so owner or occupied, including buildings, improvements, grounds, or drainage easements or other rights-of-way incident thereto, and waterscapes in a well maintained, clean and attractive condition at all times.

Such maintenance includes, but is not limited to the following:

- Prompt removal of all litter, trash, garbage, refuse and waste, other than building refuse.
- Lawn mowing on a regular basis, in summer months lawns shall be mowed at least once every fourteen (14) days.
- Periodic tree and shrub pruning to maintain a neat and healthy appearance.
- Watering by means of lawn sprinkler system and hand watering as needed to maintain in living and healthy condition all plants on the Building Site.
- Keeping lawn and planting areas alive and healthy, and any adjoining rights-of-way or swales free of weeds and attractive.
- Removing and replacing any dead plant material within 90 days after it has died or within the next planting season, whichever occurs first.
- Keeping vacant land well maintained, free of trash and tall weeds, and mowed to a height not to exceed twelve (12) inches.
- Keeping of exterior lighting and mechanical facilities in good working order.
- Maintaining water levels and water quality in waterscapes, or water amenities in common areas.

CONSTRUCTION CRITERIA

All construction employees parking and equipment storage shall be located on the construction site so as not to interfere with free passage of vehicular traffic along public streets. During construction, each tenant shall ensure that all public streets shall be kept clear of debris from its construction site. The tenant shall be responsible for construction damage to public streets, lighting, landscape and irrigation systems. The tenant of the building site under construction shall clean up any dirt, mud and debris carried from the building site by construction traffic and other construction activities.

All existing trees, planting, grass and irrigation systems shall be protected during construction by the installation of a six foot (6') chain link fence or approved protective fencing between the construction zone and the area of existing tree canopies. All disturbed areas during construction of existing vegetation shall be replaced to final condition.

Construction trailers and construction employee parking will not be allowed within/under existing trees.

REVIEWS AND SUBMITTALS

Preliminary Site Plans for submittal shall meet the following criteria:

1. Preliminary Site Plan should represent 95% complete Schematic Design level drawings containing at least the following information:
 - Platted property lines, proposed easements, building setback lines, Street Landscape Setback, existing public streets, existing trees including caliber size (DBH) and species.
 - Parking areas, including the number, type and configuration of parking spaces (including handicap spaces), driveways, fire lanes, internal streets (including drop-off areas). The Schematic Site Plan should show pedestrian areas, courtyards, plazas, fountains, lakes, ponds, miscellaneous walkways, retaining or perimeter walls or fences, sign location, trash container locations, service and utility areas.
2. Exterior elevations of all sides of buildings and site structures, including a description of exterior materials, colors, textures and shapes. Exterior perspectives or colored depictions of the building are not required but will be helpful in the review.
3. A concept landscape plan should show planting recommendations (tree species and location), general shrub and groundcover massing, annual and perennial color and grass locations and should illustrate all parking lot landscaping and service, storage and utility screening.

The final Construction Documents should represent 95% complete contract documents containing all the refined Preliminary Plan information defined above, plus the following:

- All documents shall contain registration seals of professional architects, landscape architects, interior space planners, civil, geotechnical, electrical, structural, and mechanical engineers, as applicable.
- Grading plans should illustrate all proposed contours at one (1) foot intervals.

- Complete irrigation plan (automatic system).
- Utility plans, including routing, size and location.
- Site lighting plan illustrating all fixture locations, type and fixture specifications and indicating photometric layout.
- Specific detail sheets for any and all site amenities, fixtures, and special features.